

MADE IN USA

BAY CITIES METAL PRODUCTS

1958



SERVING THE BUILDING SUPPLY
INDUSTRY FOR OVER 60 YEARS

CATALOG



QUALITY PEOPLE

QUALITY PRODUCTS

HERE AT BAY CITIES METAL PRODUCTS (BCMP), WE MANUFACTURE TOP QUALITY SHEET METAL PRODUCTS FOR WHOLESALE DISTRIBUTORS AND DO-IT-YOURSELF HOME CENTERS. AND IF WE DON'T HAVE IT, WE'LL MAKE IT. WITH OVER 100,000 SQUARE FEET OF MANUFACTURING AND WAREHOUSE SPACE, BCMP IS READY TO SERVE AND FULFILL ANY REQUEST.

To place an order:
orders@bcmet.com

For pricing and other inquiries:
sales@bcmet.com

PHONE
800-245-9047
310-660-0351

FAX
310-515-7423

PRODUCT FINDER

LINEAR AND TRANSITION FLASHING

| | |
|----------------------------------|----|
| Roof Edge With Drip | 4 |
| Gravel Guard (Low Rise) | 5 |
| Gravel Guard (HIGH Rise) | 6 |
| Roof Edge Straight | 7 |
| Shed Flashing / Roof To Wall | 7 |
| Saddle stock | 7 |
| COUNTER FLASHING | 7 |
| Z-Bar | 8 |
| Overhang Drip Edge | 8 |
| Water Table | 8 |
| Tucker Flashing | 8 |
| Coping | 8 |
| Tile PAN | 9 |
| Reroof Trim (3-Way) | 9 |
| Tile Riser | 9 |
| Bird Stop | 10 |
| W-Valley | 11 |
| Shingles | 11 |
| Step Shingles | 11 |
| Galvanized Flat Sheets | 11 |
| <i>Roofing Trim Applications</i> | 12 |
| <i>Roofing Trim Applications</i> | 13 |

ROLL FLASHING

| | |
|-------------------|----|
| Roll Valley 50 ft | 14 |
| Roll Valley 10 ft | 14 |

PIPE FLASHING

| | |
|--------------------------------------|----|
| All Pitch Flashings, Standard Base | 15 |
| All Pitch Flashings, FHA Base | 16 |
| All Pitch Flashings, DSA Base | 17 |
| <i>Pipe Flashing Selection Guide</i> | 18 |
| Solar Flashings | 19 |
| <i>Solar Flashing Applications</i> | 20 |

VENTILATION

| | |
|-------------------------|----|
| Roof Jacks (T-Top) | 21 |
| Roof Dormer | 22 |
| Gravity Vent | 22 |
| Turbine Vent | 22 |
| Gable Louver | 23 |
| Utility Louver | 23 |
| Ventilation | 24 |
| Foundation & Eave Vents | 24 |
| Crawl Hole Vent | 24 |
| Tub Access Door | 25 |
| Dryer Vent | 25 |
| Side Hood | 25 |
| Aluminum Louver Vent | 25 |

VENT PIPE & FITTINGS

| | |
|--|----|
| Vent Pipe | 26 |
| Conductor Pipe | 26 |
| Elbows | 26 |
| Rectangle to Round Adapter | 26 |
| Plumbers Tape | 27 |
| Increasesers | 27 |
| REDUCERS | 27 |
| Vent Tees & Wyes | 27 |
| Vent Pipe Collar | 27 |
| CAPS | 28 |
| Flexible Aluminum Pipe | 29 |
| Dryer Box | 29 |
| Dryer Vent Kit | 29 |
| <i>Range Hood & Bathroom Fan Vent System</i> | 30 |

DOUBLE WALL VENT PIPE & FITTINGS

| | |
|---|----|
| Round Double Wall Pipe & Accessories | 31 |
| <i>Water Heater Vent System</i> | 32 |
| Oval Double Wall Pipe & Accessories | 33 |
| <i>Wall Furnace Vent System</i> | 34 |

GUTTERS

| | |
|---------------------------------------|----|
| K4 Gutters | 35 |
| K5 Gutters | 36 |
| <i>Roof Drainage System</i> | 37 |
| <i>Easy Installation Instructions</i> | 38 |

DOWNSPOUTS

| | |
|------------------------|----|
| K4 Downspout Elbows | 39 |
| K4 Downspouts | 40 |
| Plain Round Elbows | 40 |
| Plain Square Downspout | 40 |
| Plain Square Elbows | 41 |

GUTTER ACCESSORIES

| | |
|------------------|----|
| K4 Accessories | 42 |
| K5 Accessories | 43 |
| Downspout Straps | 43 |

ROOF DRAINAGE



| | |
|--------------|----|
| Scuppers | 43 |
| Leader Heads | 43 |

DRYWALL, PLASTER, STUCCO ACCESSORIES

| | |
|---------|----|
| Drywall | 44 |
| Stucco | 45 |

LINEAR AND TRANSITION FLASHING

ROOF EDGE WITH DRIP

| | PRODUCT # | DESCRIPTION |
|--|-----------|--|
| ALL DIMENSIONS = A" X B" | | |
| | 1X2WD8 | 1" x 2" Roof Edge with Drip 28 Gauge Zincalume |
| | 1X2WD4 | 1" x 2" Roof Edge with Drip 28 Gauge Brown |
| ALSO AVAILABLE IN GRIP: | 1X2WD5 | 1" x 2" Roof Edge with Drip 28 Gauge White |
|  | 1X2WD6 | 1" x 2" Roof Edge with Drip 28 Gauge Charcoal |
|  | | |
| | 1.5WD8 | 1½" x 1½" Roof Edge with Drip 28 Gauge Zincalume |
| | 1.5WD4 | 1½" x 1½" Roof Edge with Drip 28 Gauge Brown |
| | 1.5WD5 | 1½" x 1½" Roof Edge with Drip 28 Gauge White |
| | 1.5WD6 | 1½" x 1½" Roof Edge with Drip 28 Gauge Charcoal |
| | 152WD8 | 1½" x 2" Roof Edge with Drip 28 Gauge Zincalume |
| | 152WD4 | 1½" x 2" Roof Edge with Drip 28 Gauge Brown |
| | 152WD5 | 1½" x 2" Roof Edge with Drip 28 Gauge White |
| | 152WD6 | 1½" x 2" Roof Edge with Drip 28 Gauge Charcoal |
| | 2X2WD8 | 2" x 2" Roof Edge with Drip 28 Gauge Zincalume |
| | 2X2WD4 | 2" x 2" Roof Edge with Drip 28 Gauge Brown |
| | 2X2WD5 | 2" x 2" Roof Edge with Drip 28 Gauge White |
| | 2X2WD6 | 2" x 2" Roof Edge with Drip 28 Gauge Charcoal |
|  | 2X3WD8 | 2" x 3" Roof Edge with Drip 28 Gauge Zincalume |
| | 2X3WD4 | 2" x 3" Roof Edge with Drip 28 Gauge Brown |
| | 2X3WD5 | 2" x 3" Roof Edge with Drip 28 Gauge White |
| | 2X3WD6 | 2" x 3" Roof Edge with Drip 28 Gauge Charcoal |
| | 2X4WD8 | 2" x 4" Roof Edge with Drip 28 Gauge Zincalume |
| | 2X4WD4 | 2" x 4" Roof Edge with Drip 28 Gauge Brown |
| | 2X4WD5 | 2" x 4" Roof Edge with Drip 28 Gauge White |
| | 2X4WD6 | 2" x 4" Roof Edge with Drip 28 Gauge Charcoal |
| | 3X3WD8 | 3" x 3" Roof Edge with Drip 28 Gauge Zincalume |
| | 3X3WD4 | 3" x 3" Roof Edge with Drip 28 Gauge Brown |
| | 3X3WD5 | 3" x 3" Roof Edge with Drip 28 Gauge White |
| | 3X3WD6 | 3" x 3" Roof Edge with Drip 28 Gauge Charcoal |
| | 4X4WD8 | 4" x 4" Roof Edge with Drip 28 Gauge Zincalume |
| | 4X4WD4 | 4" x 4" Roof Edge with Drip 28 Gauge Brown |
| | 4X4WD5 | 4" x 4" Roof Edge with Drip 28 Gauge White |
| | 4X4WD6 | 4" x 4" Roof Edge with Drip 28 Gauge Charcoal |

AVAILABLE IN 26 GAUGE



LINEAR AND TRANSITION FLASHING

GRAVEL GUARD (LOW RISE)

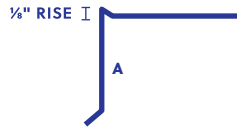

| PRODUCT # | DESCRIPTION |
|------------------------|--|
| 6GG28($\frac{1}{8}$) | 6" Gravel Guard 2" Face (A) - $\frac{1}{8}$ " Rise 28 Gauge Zincolume |
| 6GG24($\frac{1}{8}$) | 6" Gravel Guard 2" Face (A) - $\frac{1}{8}$ " Rise 28 Gauge Brown |
| 6GG25($\frac{1}{8}$) | 6" (A) Gravel Guard 2" Face (A) - $\frac{1}{8}$ " Rise 28 Gauge White |
| 6GG26($\frac{1}{8}$) | 6" (A) Gravel Guard 2" Face (A) - $\frac{1}{8}$ " Rise 28 Gauge Charcoal |
| 6GG38($\frac{1}{8}$) | 6" Gravel Guard 3" Face (A) - $\frac{1}{8}$ " Rise 28 Gauge Zincolume |
| 6GG34($\frac{1}{8}$) | 6" Gravel Guard 3" Face (A) - $\frac{1}{8}$ " Rise 28 Gauge Brown |
| 6GG35($\frac{1}{8}$) | 6" Gravel Guard 3" Face (A) - $\frac{1}{8}$ " Rise 28 Gauge White |
| 6GG36($\frac{1}{8}$) | 6" Gravel Guard 3" Face (A) - $\frac{1}{8}$ " Rise 28 Gauge Charcoal |
| 7GG38($\frac{1}{8}$) | 7" Gravel Guard 3" Face (A) - $\frac{1}{8}$ " Rise 28 Gauge Zincolume |
| 7GG34($\frac{1}{8}$) | 7" Gravel Guard 3" Face (A) - $\frac{1}{8}$ " Rise 28 Gauge Brown |
| 7GG35($\frac{1}{8}$) | 7" Gravel Guard 3" Face (A) - $\frac{1}{8}$ " Rise 28 Gauge White |
| 7GG36($\frac{1}{8}$) | 7" Gravel Guard 3" Face (A) - $\frac{1}{8}$ " Rise 28 Gauge Charcoal |
| 8GG48($\frac{1}{8}$) | 8" Gravel Guard 4" Face (B) - $\frac{1}{8}$ " Rise 28 Gauge Zincolume |
| 8GG44($\frac{1}{8}$) | 8" Gravel Guard 4" Face (A) - $\frac{1}{8}$ " Rise 28 Gauge Brown |
| 8GG45($\frac{1}{8}$) | 8" Gravel Guard 4" Face (A) - $\frac{1}{8}$ " Rise 28 Gauge White |
| 8GG46($\frac{1}{8}$) | 8" Gravel Guard 4" Face (A) - $\frac{1}{8}$ " Rise 28 Gauge Charcoal |

AVAILABLE IN 26 GAUGE

LINEAR AND TRANSITION FLASHING

GRAVEL GUARD (HIGH RISE)

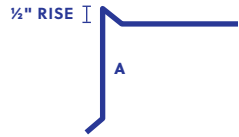

| PRODUCT # | DESCRIPTION |
|-----------|--|
| 6GG28 | 6" Gravel Guard 2" Face (A) - ½" Rise 28 Gauge Zincalume |
| 6GG24 | 6" Gravel Guard 2" Face (A) - ½" Rise 28 Gauge Brown |
| 6GG25 | 6" Gravel Guard 2" Face (A) - ½" Rise 28 Gauge White |
| 6GG26 | 6" Gravel Guard 2" Face (A) - ½" Rise 28 Gauge Charcoal |
| 6GG38 | 6" Gravel Guard 3" Face (A) - ½" Rise 28 Gauge Zincalume |
| 6GG34 | 6" Gravel Guard 3" Face (A) - ½" Rise 28 Gauge Brown |
| 6GG35 | 6" Gravel Guard 3" Face (A) - ½" Rise 28 Gauge White |
| 6GG36 | 6" Gravel Guard 3" Face (A) - ½" Rise 28 Gauge Charcoal |
| 7GG38 | 7" Gravel Guard 3" Face (A) - ½" Rise 28 Gauge Zincalume |
| 7GG34 | 7" Gravel Guard 3" Face (A) - ½" Rise 28 Gauge Brown |
| 7GG35 | 7" Gravel Guard 3" Face (A) - ½" Rise 28 Gauge White |
| 7GG36 | 7" Gravel Guard 3" Face (A) - ½" Rise 28 Gauge Charcoal |
| 8GG48 | 8" Gravel Guard 4" Face (A) - ½" Rise 28 Gauge Zincalume |
| 8GG44 | 8" Gravel Guard 4" Face (A) - ½" Rise 28 Gauge Brown |
| 8GG45 | 8" Gravel Guard 4" Face (A) - ½" Rise 28 Gauge White |
| 8GG46 | 8" Gravel Guard 4" Face (A) - ½" Rise 28 Gauge Charcoal |

AVAILABLE IN 26 GAUGE

LINEAR AND TRANSITION FLASHING

ROOF EDGE STRAIGHT

| | PRODUCT # | DESCRIPTION |
|---|-----------|---|
|  <p>ALL DIMENSIONS = A" x B"</p> | 1X18 | 1" x 1" Roof Edge Straight 28 Gauge Zincalume |
| | 1X28 | 1" x 2" Roof Edge Straight 28 Gauge Zincalume |
| | 1X38 | 1" x 3" Roof Edge Straight 28 Gauge Zincalume |
| | 1.58 | 1½" x 1½" Roof Edge Straight 28 Gauge Zincalume |
| | 2X28 | 2" x 2" Roof Edge Straight 28 Gauge Zincalume |
| | 2X38 | 2" x 3" Roof Edge Straight 28 Gauge Zincalume |
| | 2X48 | 2" x 4" Roof Edge Straight 28 Gauge Zincalume |
| | 3X38 | 3" x 3" Roof Edge Straight 28 Gauge Zincalume |
| | 3X48 | 3" x 4" Roof Edge Straight 28 Gauge Zincalume |
| | 4X48 | 4" x 4" Roof Edge Straight 28 Gauge Zincalume |
| | 4X68 | 4" x 6" Roof Edge Straight 28 Gauge Zincalume |
| | 6X68 | 6" x 6" Roof Edge Straight 28 Gauge Zincalume |

AVAILABLE IN 26 GAUGE

SHED FLASHING / ROOF TO WALL

| | PRODUCT # | DESCRIPTION |
|---|-----------|---|
|  <p>ALL DIMENSIONS = A" x B"</p> | 2X4SF8 | 2" x 4" Shed Flashing 110° 28 Gauge Zincalume |
| | RTW8 | 2" x 6" Roof To Wall 110° 28 Gauge Zincalume |
| | 3X5RTW8 | 3" x 5" Roof To Wall 110° 28 Gauge Zincalume |

AVAILABLE IN 26 GAUGE

SADDLE STOCK



| | |
|-------|--|
| 18SS8 | 4" x 14" Saddle Stock 26 Gauge Zincalume |
|-------|--|

COUNTER FLASHING



| | |
|--------|--|
| 3.5CF8 | ½" x 3" (A) Counter Flashing 28 Gauge Zincalume |
| 5.5CF8 | ½" x 5" (A) Counter Flashing 28 Gauge Zincalume |
| 6CF8 | ½" x 5½" (A) Counter Flashing 28 Gauge Zincalume |

AVAILABLE IN 26 GAUGE

LINEAR AND TRANSITION FLASHING

Z-BAR

| | PRODUCT # | DESCRIPTION |
|-----------------------------------|--|--|
| A = LENGTH BEFORE BENDING. | 2Z3/88 | 2" Z Bar (A) ($\frac{3}{8}$ " Center) 28 Gauge Zincalume |
| | 2Z1/28 | 2" Z Bar (A) ($\frac{1}{2}$ " Center) 28 Gauge Zincalume |
| | 2Z5/88 | 2" Z Bar (A) ($\frac{5}{8}$ " Center) 28 Gauge Zincalume |
| | 3Z3/88 | 3" Z Bar (A) ($\frac{3}{8}$ " Center) 28 Gauge Zincalume |
| | 3Z1/28 | 3" Z Bar (A) ($\frac{1}{2}$ " Center) 28 Gauge Zincalume |
| | 3Z5/88 | 3" Z Bar (A) ($\frac{5}{8}$ " Center) 28 Gauge Zincalume |
| | 3Z3/48 | 3" Z Bar (A) ($\frac{3}{4}$ " Center) 28 Gauge Zincalume |
| | 5Z3/8 | 5" Z Bar (A) ($\frac{3}{8}$ " Center) 28 Gauge Galvanized |
| | 5Z1/2 | 5" Z Bar (A) ($\frac{1}{2}$ " Center) 28 Gauge Galvanized |
| | 5Z5/8 | 5" Z Bar (A) ($\frac{5}{8}$ " Center) 28 Gauge Galvanized |
| 5Z3/4 | 5" Z Bar (A) ($\frac{3}{4}$ " Center) 28 Gauge Galvanized | |
| 5Z1 | 5" Z Bar (A) (1" Center) 28 Gauge Galvanized | |
| 6Z1 | 6" Z Bar (1" Center) 28 Gauge Galvanized | |
| 6Z18 | 6" Z Bar (1" Center) 28 Gauge Zincalume | |



5" AND 6" AVAILABLE IN 26 GAUGE

OVERHANG DRIP EDGE

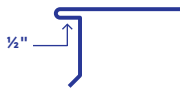

| | |
|-------|--|
| OHDE2 | Overhang Drip Edge 2" Face 28 Gauge Galvanized |
|-------|--|

WATER TABLE

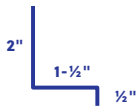

| | |
|------|---|
| 4WT8 | 2" x 1 $\frac{1}{2}$ " x $\frac{1}{2}$ " Water Table 28 Gauge Zincalume |
|------|---|

TUCKER FLASHING



| | |
|-------|---|
| 4.5TF | 4 $\frac{1}{2}$ " Tucker Flashing 28 Gauge Galvanized |
|-------|---|

COPING



| | |
|------|---|
| 10C8 | 2" x 6" (A) x 2" Coping Metal 28 Gauge Zincalume |
| 12C8 | 2" x 8" (A) x 2" Coping Metal 28 Gauge Zincalume |
| 14C8 | 2" x 10" (A) x 2" Coping Metal 28 Gauge Zincalume |

AVAILABLE IN 26 GAUGE



LINEAR AND TRANSITION FLASHING

TILE PAN

DIMENSIONS = A" x B" x C"

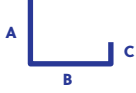

PRODUCT

DESCRIPTION

| | |
|--------|---|
| 8TP8 | 3½" x 4" x ½" Tile Pan 28 Gauge Zincolume |
| 8.5TP8 | 4" x 4" x ½" Tile Pan 28 Gauge Zincolume |
| 10TP8 | 3½" x 6" x ½" Tile Pan 28 Gauge Zincolume |
| 12TP8 | 4" x 7" x 1" Tile Pan 28 Gauge Zincolume |

AVAILABLE IN 26 GAUGE

REROOF TRIM (3-WAY)

| | |
|-----------|---|
| 4RRT(1⅛) | 4" Reroof Trim (1⅛" Face) 28 Gauge Galvanized |
| 4RRT4(1⅛) | 4" Reroof Trim (1⅛" Face) 28 Gauge Brown |
| 4RRT5(1⅛) | 4" Reroof Trim (1⅛" Face) 28 Gauge White |
| 4RRT6(1⅛) | 4" Reroof Trim (1⅛" Face) 28 Gauge Charcoal |

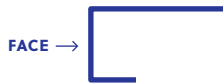

| | |
|-------|--|
| 4RRT | 4" Reroof Trim (¼" Face) 28 Gauge Galvanized |
| 4RRT4 | 4" Reroof Trim (¼" Face) 28 Gauge Brown |
| 4RRT5 | 4" Reroof Trim (¼" Face) 28 Gauge White |
| 4RRT6 | 4" Reroof Trim (¼" Face) 28 Gauge Charcoal |

| | |
|-----------|---|
| 4RRT(1½) | 4" Reroof Trim (1½" Face) 28 Gauge Galvanized |
| 4RRT4(1½) | 4" Reroof Trim (1½" Face) 28 Gauge Brown |
| 4RRT5(1½) | 4" Reroof Trim (1½" Face) 28 Gauge White |
| 4RRT6(1½) | 4" Reroof Trim (1½" Face) 28 Gauge Charcoal |

AVAILABLE IN 26 GAUGE

TILE RISER

| | |
|------|--|
| TRA4 | 1½" Face 4" Tile Riser 90° 28 Gauge Brown |
| TRA5 | 1½" Face 4" Tile Riser 90° 28 Gauge White |
| TRA6 | 1½" Face 4" Tile Riser 90° 28 Gauge Charcoal |



| | |
|-----------|---|
| TRA4(7/8) | ⅞" Face 4" Tile Riser 90° 28 Gauge Brown |
| TRA5(7/8) | ⅞" Face 4" Tile Riser 90° 28 Gauge White |
| TRA6(7/8) | ⅞" Face 4" Tile Riser 90° 28 Gauge Charcoal |

AVAILABLE IN 26 GAUGE



LINEAR AND TRANSITION FLASHING

BIRD STOP

PRODUCT

DESCRIPTION



BSCMR

Claymax Terra Cotta



BSUSTB

U.S. Tile Black

BSUSTBR

U.S. Tile Brown

BSUSTR

U.S. Tile Terra Cotta



BSECB

Eagle Capistrano Black

BSECBR

Eagle Capistrano Brown

BSECR

Eagle Capistrano Terra Cotta



BSEMB

Eagle Malibu Black

BSEMBR

Eagle Malibu Brown

BSEMR

Eagle Malibu Terra Cotta



BSHRB

Hanson Regal Black

BSHRR

Hanson Regal Terra Cotta



BSLEB

Lifetile Espana Black

BSLEBR

Lifetile Espana Brown

BSLER

Lifetile Espana Terra Cotta



BSMVB

Monier Villa Black

BSMVR

Monier Villa Terra Cotta



BSWB

Westile Mission Black

BSWR

Westile Mission Terra Cotta

LINEAR AND TRANSITION FLASHING

W-VALLEY

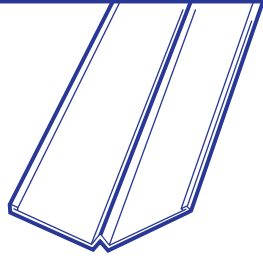

PRODUCT

DESCRIPTION

| | |
|-------|--|
| 18WV | 18" W Valley 1" Rise 28 Gauge Galvanized |
| 18WV4 | 18" W Valley 1" Rise 28 Gauge Brown |
| 18WV5 | 18" W Valley 1" Rise 28 Gauge White |
| 18WV6 | 18" W Valley 1" Rise 28 Gauge Charcoal |
| 18WV7 | 18" W Valley 1" Rise 28 Gauge Copper |
| 18WV8 | 18" W Valley 1" Rise 28 Gauge Zincolume |

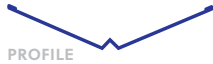

PROFILE

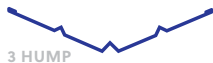

3 HUMP

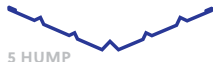

5 HUMP

| | |
|-------|--|
| 24WV | 24" W Valley 1" Rise 28 Gauge Galvanized |
| 24WV4 | 24" W Valley 1" Rise 28 Gauge Brown |
| 24WV5 | 24" W Valley 1" Rise 28 Gauge White |
| 24WV6 | 24" W Valley 1" Rise 28 Gauge Charcoal |
| 24WV7 | 24" W Valley 1" Rise 28 Gauge Copper |
| 24WV8 | 24" W Valley 1" Rise 28 Gauge Zincolume |

AVAILABLE IN 26 GAUGE

3 & 5 HUMP AVAILABLE FOR 24" W VALLEY

SHINGLES



| | |
|-----------|--------------------------------------|
| 5X7GS(50) | 5" x 7" Shingles 28 Gauge Zincolume |
| 6X8GS | 6" x 8" Shingles 28 Gauge Zincolume |
| 8X12GS | 8" x 12" Shingles 28 Gauge Zincolume |

| | |
|------------|--|
| 5X7PGS(50) | 5" x 7" Shingles 28 Gauge Painted Brown |
| 6X8PGS | 6" x 8" Shingles 28 Gauge Painted Brown |
| 8X12PGS | 8" x 12" Shingles 28 Gauge Painted Brown |

AVAILABLE IN 26 GAUGE

SOLD IN BUNDLES OF 50 ONLY

STEP SHINGLES

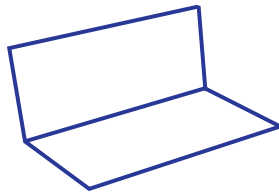

| | |
|--------------|---|
| 6X8GSS(10) | 6" X 8" Step Shingle (Bent 3"x 3") 28 Gauge Zincolume |
| 8X8GSS(10) | 8" x 8" Step Shingle (Bent 4" x 4") 28 Gauge Galvanized |
| 8X12GSS | 8" x 12" Step Shingle (Bent 4"x 4") 28 Gauge Zincolume |
| 8X14GSS | 8" x 14" Step Shingle (Bent 4"x 4") 28 Gauge Galvanized |
| 12X12GSS(10) | 12" x 12" Step Shingle (Bent 6" x 6") 28 Gauge Galvanized |

SOLD IN BUNDLES OF 10 ONLY

GALVANIZED FLAT SHEETS

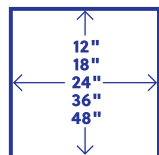

| | |
|---------|--|
| 12X36FS | 12" x 36" Flat Sheet 30 Gauge Galvanized |
| 18X36FS | 18" x 36" Flat Sheet 30 Gauge Galvanized |
| 24X36FS | 24" x 36" Flat Sheet 30 Gauge Galvanized |
| 36X36FS | 36" x 36" Flat Sheet 30 Gauge Galvanized |
| 48X36FS | 48" x 36" Flat Sheet 30 Gauge Galvanized |



ROOFING TRIM APPLICATIONS

Metal reroofing trim conceals old roofing, ensures a neat straight edge, and gives a professional appearance.

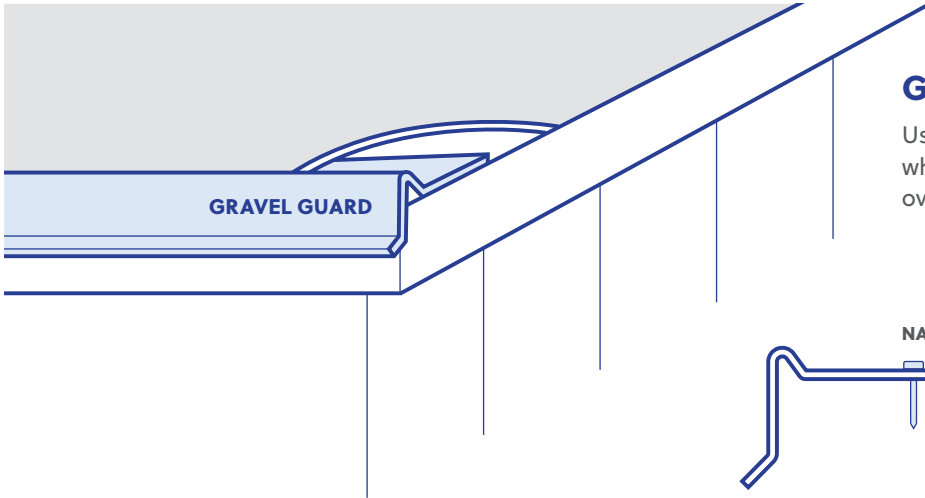

GRAVEL GUARD

Used as trim for 90 lb. rolled roof or where cold patch repairs are made over old hot mop roof.

Nail only as indicated.
Do not nail on exposed face.

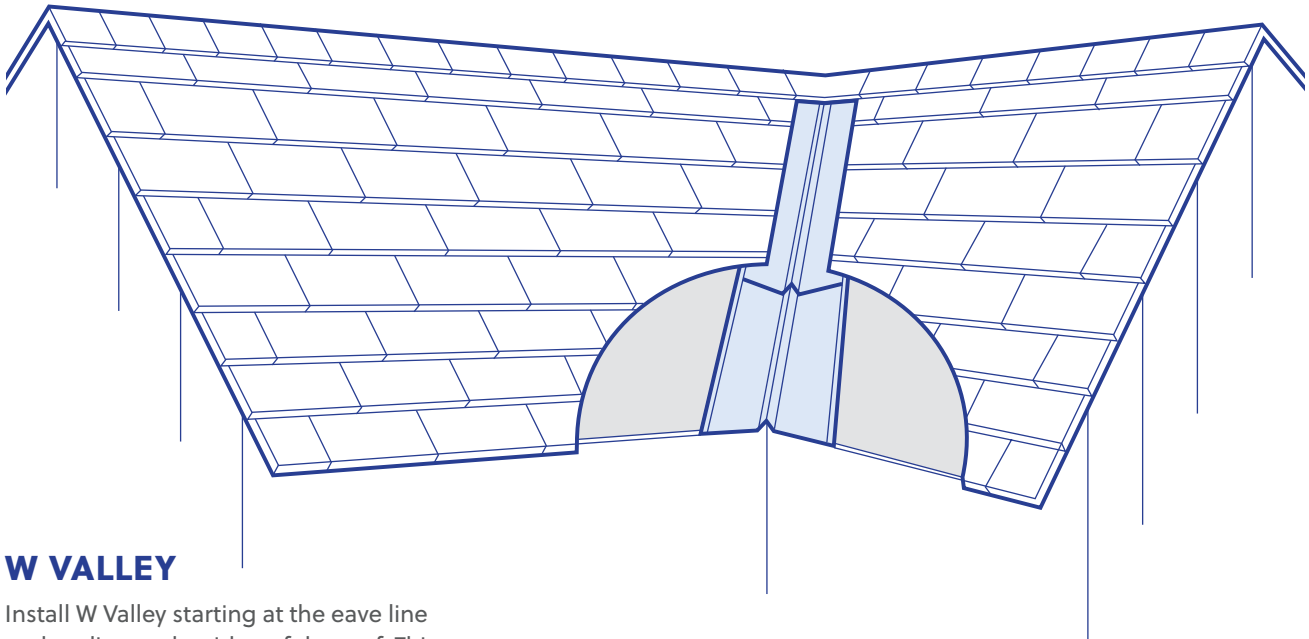

W VALLEY

Install W Valley starting at the eave line and ending at the ridge of the roof. This will give the correct overlap. The overlap should be 6–8 inches depending on the pitch of the roof. The lower the pitch of the roof, the larger the overlap.

Never nail through the valley. Drive the nails outside the valley and bend the nails down to secure the valley as shown to the right.



Note: Contact your local code authorities for all questions regarding building code requirements.



13 **ROOFING TRIM APPLICATIONS**

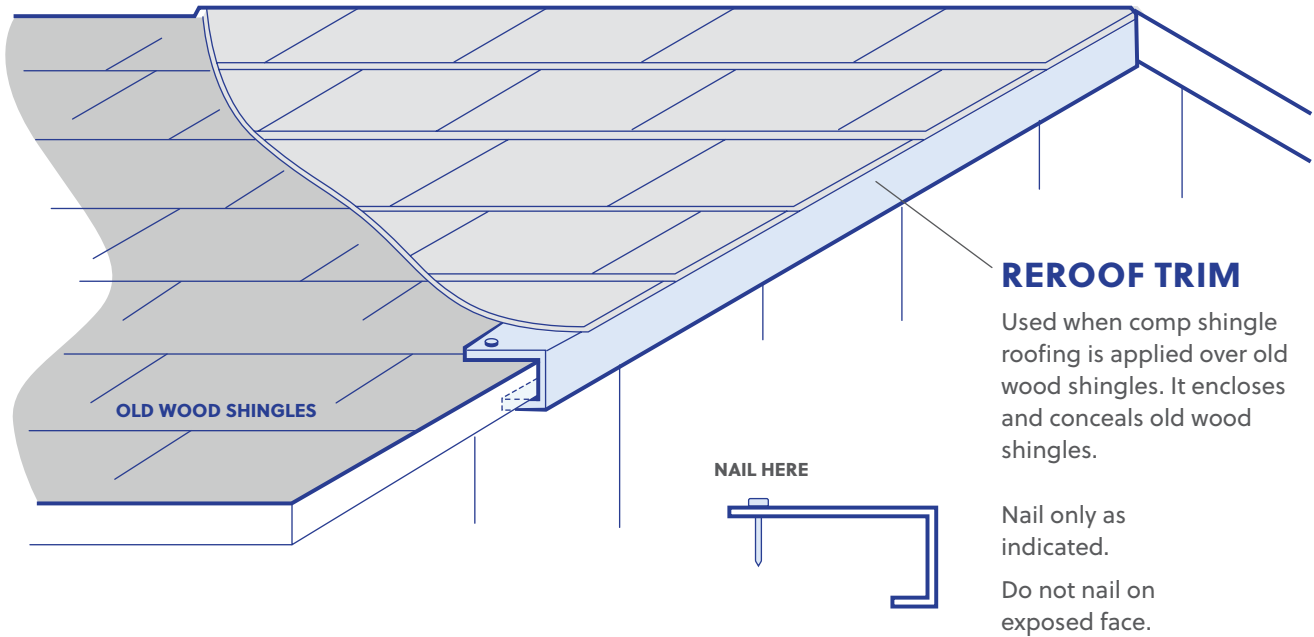
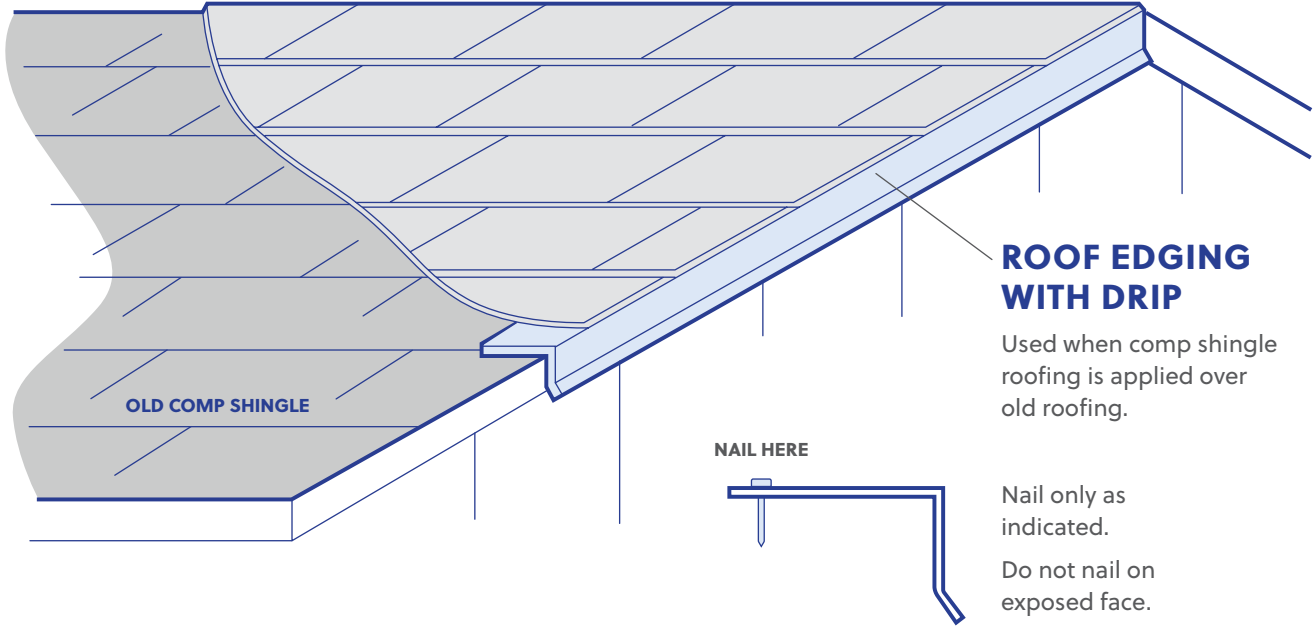

ROLL FLASHING

ROLL VALLEY 50 FT

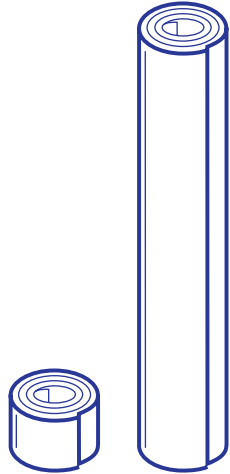

4" TO 20"

PRODUCT

DESCRIPTION

| | |
|--------|-------------------------------------|
| 4ARV | 4" x 50' Roll Valley Aluminum |
| 6ARV | 6" x 50' Roll Valley Aluminum |
| 8ARV | 8" x 50' Roll Valley Aluminum |
| 10ARV | 10" x 50' Roll Valley Aluminum |
| 12ARV | 12" x 50' Roll Valley Aluminum |
| 14ARV | 14" x 50' Roll Valley Aluminum |
| 20ARV | 20" x 50' Roll Valley Aluminum |
| 8GRV | 8" x 50' Roll Valley Galvanized |
| 14GRV | 14" x 50' Roll Valley Galvanized |
| 20GRV | 20" x 50' Roll Valley Galvanized |
| 8PGRV | 8" x 50' Roll Valley Painted Brown |
| 14PGRV | 14" x 50' Roll Valley Painted Brown |
| 20PGRV | 20" x 50' Roll Valley Painted Brown |

ROLL VALLEY 10 FT

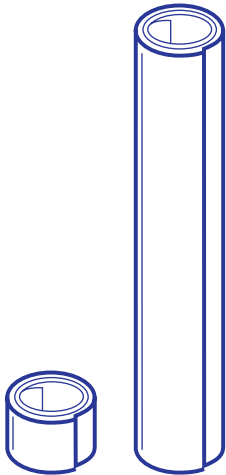

6" TO 20"

| | |
|----------|-------------------------------------|
| 6ARV10 | 6" x 10' Roll Valley Aluminum |
| 8ARV10 | 8" x 10' Roll Valley Aluminum |
| 14ARV10 | 14" x 10' Roll Valley Aluminum |
| 20ARV10 | 20" x 10' Roll Valley Aluminum |
| 8GRV10 | 8" x 10' Roll Valley Galvanized |
| 14GRV10 | 14" x 10' Roll Valley Galvanized |
| 20GRV10 | 20" x 10' Roll Valley Galvanized |
| 8PGRV10 | 8" x 10' Roll Valley Painted Brown |
| 14PGRV10 | 14" x 10' Roll Valley Painted Brown |
| 20PGRV10 | 20" x 10' Roll Valley Painted Brown |
| 8PWGRV10 | 8" x 10' Roll Valley Painted White |

PIPE FLASHING

ALL PITCH FLASHINGS STANDARD BASE

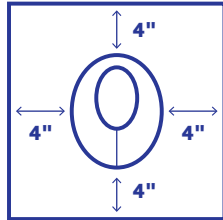

STANDARD BASE

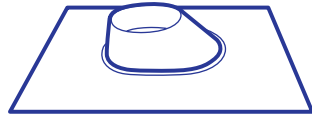

| PRODUCT # | DESCRIPTION |
|-----------|--|
| .5APF | ½" All Pitch Flashing |
| .75APF | ¾" All Pitch Flashing |
| 1APF | 1" All Pitch Flashing |
| 1.25APF | 1¼" All Pitch Flashing |
| 1.5APF | 1½" All Pitch Flashing |
| 2APF | 2" All Pitch Flashing |
| 3APF | 3" All Pitch Flashing |
| 3APFT | 3" All Pitch Flashing (Transite Pipe) |
| 3APFS | 3" All Pitch Flashing (Soil Pipe) |
| 3DW | 3" All Pitch Flashing (Double Wall Pipe) |
| 4APF | 4" All Pitch Flashing |
| 4APFT | 4" All Pitch Flashing (Transite Pipe) |
| 4APFS | 4" All Pitch Flashing (Soil Pipe) |
| 4DW | 4" All Pitch Flashing (Double Wall) |
| 5APF | 5" All Pitch Flashing |
| 5APFT | 5" All Pitch Flashing (Transite Pipe) |
| 5DW | 5" All Pitch Flashing (Double Wall) |
| 6APF | 6" All Pitch Flashing |
| 7APF | 7" All Pitch Flashing |
| 8APF | 8" All Pitch Flashing |
| 4OF | 4" All Pitch Flashing (Oval Pipe) |
| 6OF | 6" All Pitch Flashing (Oval Pipe) |

ALL FLASHINGS MADE IN 26 GAUGE

PIPE FLASHING

ALL PITCH FLASHINGS

FHA BASE

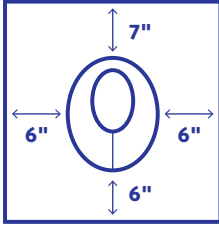

FHA BASE

PRODUCT # DESCRIPTION

.5APFF ½" All Pitch Flashing
.75APFF ¾" All Pitch Flashing

1APFF 1" All Pitch Flashing
1.25APFF 1¼" All Pitch Flashing
1.5APFF 1½" All Pitch Flashing

2APFF 2" All Pitch Flashing

3APFF 3" All Pitch Flashing
3APFTF 3" All Pitch Flashing (Transite Pipe)
3APFSF 3" All Pitch Flashing (Soil Pipe)
3DWF 3" All Pitch Flashing (Double Wall)

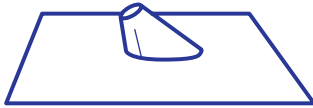

4APFF 4" All Pitch Flashing
4APFTF 4" All Pitch Flashing (Transite Pipe)
4APFSF 4" All Pitch Flashing (Soil Pipe)
4DWF 4" All Pitch Flashing (Double Wall)

5APFF 5" All Pitch Flashing
5APFTF 5" All Pitch Flashing (Transite Pipe)
5DWF 5" All Pitch Flashing (Double Wall)

6APFF 6" All Pitch Flashing

7APFF 7" All Pitch Flashing

8APFF 8" All Pitch Flashing

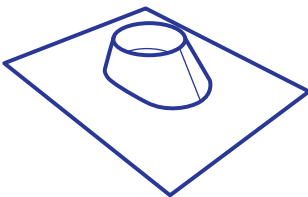

4OFF 4" All Pitch Flashing (Oval Pipe)
5OFF 5" All Pitch Flashing (Oval Pipe)

ALL FLASHINGS MADE IN 26 GAUGE
ALL PITCH FLASHINGS WITH FHA BASE AVAILABLE UP TO 16" OPENING

PIPE FLASHING

ALL PITCH FLASHINGS

DSA BASE

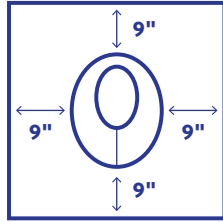

ALUMINUM BASE

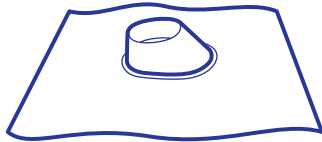

| PRODUCT # | DESCRIPTION |
|-----------|--|
| .5APFA | ½" All Pitch Flashing, Aluminum Base |
| .75APFA | ¾" All Pitch Flashing, Aluminum Base |
| 1APFA | 1" All Pitch Flashing, Aluminum Base |
| 1.25APFA | 1¼" All Pitch Flashing, Aluminum Base |
| 1.5APFA | 1½" All Pitch Flashing, Aluminum Base |
| 2APFA | 2" All Pitch Flashing, Aluminum Base |
| 3APFA | 3" All Pitch Flashing, Aluminum Base |
| 3APFTA | 3" All Pitch Flashing (Transite Pipe), Aluminum Base |
| 3APFSA | 3" All Pitch Flashing (Soil Pipe), Aluminum Base |
| 3DWA | 3" All Pitch Flashing Double Wall, Aluminum Base |
| 4APFA | 4" All Pitch Flashing, Aluminum Base |
| 4APFTA | 4" All Pitch Flashing (Transite Pipe), Aluminum Base |
| 4APFSA | 4" All Pitch Flashing (Soil Pipe), Aluminum Base |
| 4DWA | 4" All Pitch Flashing (Double Wall), Aluminum Base |
| 5APFA | 5" All Pitch Flashing, Aluminum Base |
| 6APFA | 6" All Pitch Flashing, Aluminum Base |
| 7APFA | 7" All Pitch Flashing, Aluminum Base |
| 8APFA | 8" All Pitch Flashing, Aluminum Base |
| 4OAPFA | 4" All Pitch Flashing (Oval Pipe), Aluminum Base |
| 5OAPFA | 5" All Pitch Flashing (Oval Pipe), Aluminum Base |
| 6OAPFA | 6" All Pitch Flashing (Oval Pipe), Aluminum Base |

ALL PITCH FLASHINGS WITH DSA BASE AVAILABLE UP TO 14" OPENING

PIPE FLASHING SELECTION GUIDE

Before placing your order, read this guide carefully. It may be difficult to choose the correct flashing because of conflicting or overlapping codes. The following information will help you select the right flashing for specific installations.

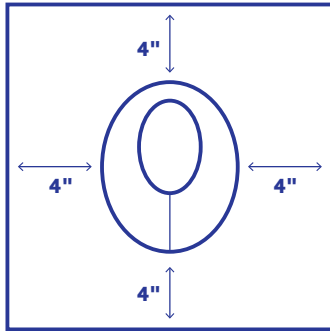

STANDARD FLASHING

Generally acceptable for composition or shingle roofs unless pitch of roof, roofing material or shingle exposure is unusual. Always check your codes before proceeding.

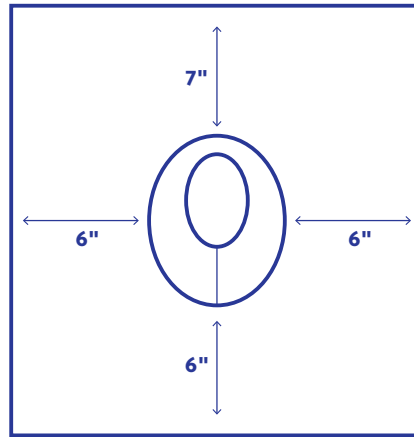

FHA FLASHING

FHA Standards require the FHA Flashing shown above.

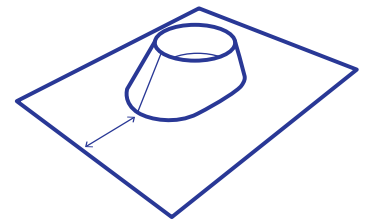

Dimensions shown are measured from base of cone to edge of flashing base.

All pipes have a common inner dimension.

Conductor Flashing Single wall pipe in which the true outside diameter of the pipe is the exact size as the flashing's top opening (Example 4").

Soil Flashing Single wall pipe where the inner diameter is the same as the conductor but the wall thickness is 3/8 of an inch larger (Example 4^{3/8}").

Double Wall Flashing A pipe which has two walls of metal separated by an air gap and where the outside diameter is 1/2 inch larger. The inner diameter is the same as the conductor and the soil (Example 4^{1/2}").

Transite Flashing Single wall pipe where the inner diameter of the pipe is the same as a Conductor, Soil, and Double Wall, but the outer diameter is 7/8 inch larger (Example 4^{7/8}").

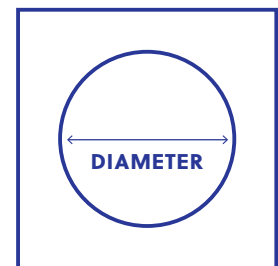

Steep pitch flashings available upon request.

PIPE FLASHING

SOLAR FLASHINGS

PRODUCT

DESCRIPTION

| | |
|----------|--|
| .5APFS | ½" IP = Solar Pipe Flashing Standard Galvanized Base ¾" SP |
| .75APFS | ¾" IP = Solar Pipe Flashing Standard Galvanized Base 1" SP |
| 1APFS | 1" IP = Solar Pipe Flashing Standard Galvanized Base 1¼" SP |
| 1.25APFS | 1¼" IP = Solar Pipe Flashing Standard Galvanized Base 1½" SP |



| | |
|-----------|---|
| .5APFFS | ½" IP = Solar Pipe Flashing FHA Galvanized Base ¾" SP |
| .75APFFS | ¾" IP = Solar Pipe Flashing FHA Galvanized Base 1" SP |
| 1APFFS | 1" IP = Solar Pipe Flashing FHA Galvanized Base 1¼" SP |
| 1.25APFFS | 1¼" IP = Solar Pipe Flashing FHA Galvanized Base 1½" SP |

| | |
|-----------|---|
| .5APFAS | ½" IP = Solar Pipe Flashing Aluminum Base ¾" SP |
| .75APFAS | ¾" IP = Solar Pipe Flashing Aluminum Base 1" SP |
| 1APFAS | 1" IP = Solar Pipe Flashing Aluminum Base 1¼" SP |
| 1.25APFAS | 1¼" IP = Solar Pipe Flashing Aluminum Base 1½" SP |

ALL GALVANIZED FLASHINGS MADE IN 26 GAUGE

NOTE:

Diameter of opening is greater than dimension in Product # due to differences between roofing and solar callouts. e.g: 1APFS opening is 1 ⅜" and 1.25APFS is 1 ¾". Please call your Sales Rep for more information.



SOLAR FLASHING APPLICATIONS

Round, low cone will fit the shortest solar stand application and accomodate all different stand styles.

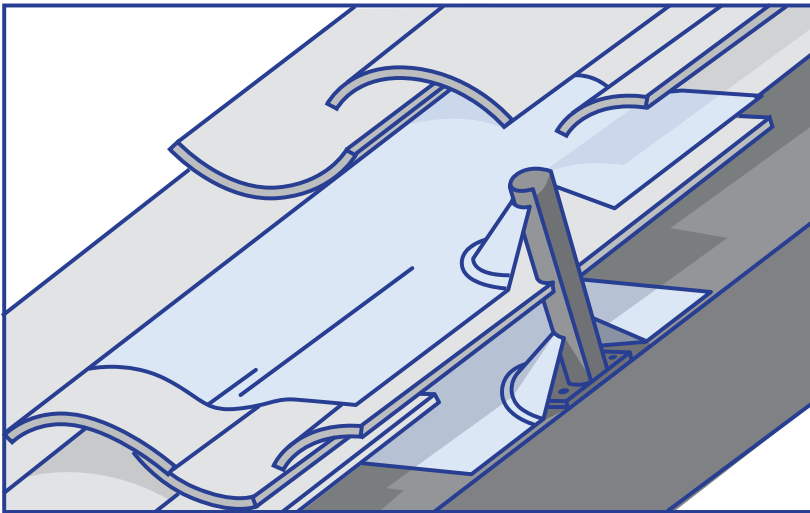
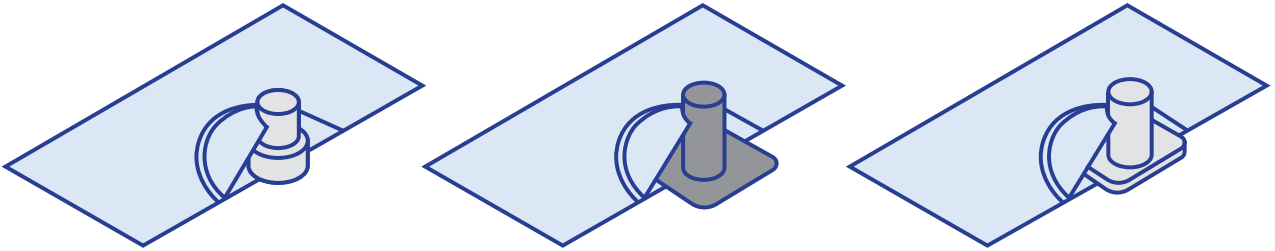

CLAY TILE INSTALLATION

SIZES:

- Standard base
- FHA base
- DSA base

MATERIALS:

- 26 gauge (.019) Galvanized G90
- 20 gauge (.032) Dead Soft Aluminum
- Stainless Steel

VENTILATION

ROOF JACKS (T-TOP)

PRODUCT #

DESCRIPTION

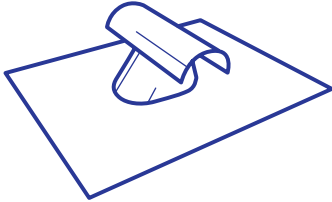

| | |
|-----------|--|
| 4RJ(26) | 4" Roof Jack 26 Gauge |
| 7RJ(26) | 7" Roof Jack 26 Gauge |
| 4RJ(26)WS | 4" Roof Jack 26 Gauge w/Screen & End Cap |
| 7RJ(26)WS | 7" Roof Jack 26 Gauge w/Screen & End Cap |

| | |
|----------|--|
| 4RJDSA | 4" Roof Jack Dead Soft Aluminum |
| 7RJDSA | 7" Roof Jack Dead Soft Aluminum |
| 4RJDSAWS | 4" Roof Jack Dead Soft Aluminum w/Screen & End Cap |
| 7RJDSAWS | 7" Roof Jack Dead Soft Aluminum w/Screen & End Cap |

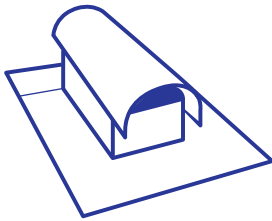

| | |
|-----------|---|
| 4X11RRJ | 4" x 11" Rectangular Roof Jack |
| 4X11RRJWS | 4" x 11" Rectangular Roof Jack w/Screen and End Cap |

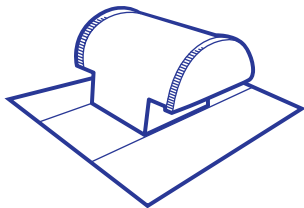

| | |
|----------|---|
| 6X6SRJ | 6" x 6" Square Roof Jack |
| 6X6SRJWS | 6" x 6" Square Roof Jack w/Screen & End Cap (shown) |

¼" MESH (¼" MESH AVAILABLE UPON REQUEST)

VENTILATION

MADE WITH 1/8" MESH (1/4" MESH AVAILABLE UPON REQUEST)

ROOF DORMER

PRODUCT #

DESCRIPTION

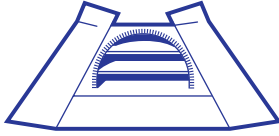

9X18RDDSA(1/8) 9" x 18" Roof Dormer DSA
12X24RDDSA(1/8) 12 x 24" Roof Dormer DSA

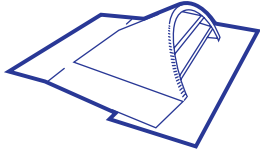

9X18RD(1/8) 9" x 18" Roof Dormer Galvanized
12X24RD(1/8) 12 x 24" Roof Dormer Galvanized



9X18DB 9" x 18" Dormer Sub-base
12X24DB 12" x 24" Dormer Sub-base

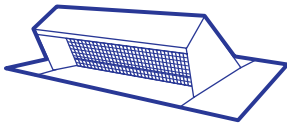

P50(1/8) 4½" X 20" Rectangular Roof Dormer (Low Profile)
P100(1/8) 7½" X 20" Rectangular Roof Dormer (Low Profile)
P200(1/8) 8½" X 30" Rectangular Roof Dormer (Low Profile)

GRAVITY VENT

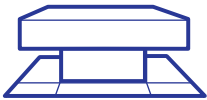

12X12GV(1/8) 12" X 12" Gravity Vent
14X14GV(1/8) 14" X 14" Gravity Vent

CUSTOM SIZES AVAILABLE UPON REQUEST

TURBINE VENT

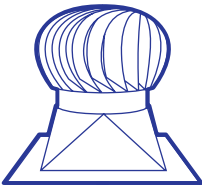

8TB 8" Turbine Vent
10TB 10" Turbine Vent
12TB 12" Turbine Vent
14TB 14" Turbine Vent
16TB 16" Turbine Vent
18TB 18" Turbine Vent
20TB 20" Turbine Vent
24TB 24" Turbine Vent

TOP AND BASE ALSO SOLD SEPERATELY



VENTILATION

MADE WITH 1/8" MESH (1/4" MESH AVAILABLE UPON REQUEST)

GABLE LOUVER

PRODUCT #

DESCRIPTION



14X12GL(1/8) 14" x 12" Gable Louver Galvanized
 14X18GL(1/8) 14" x 18" Gable Louver Galvanized
 14X24GL(1/8) 14" x 24" Gable Louver Galvanized

14X12GLFM(1/8) 14" x 12" Gable Louver Flush Galvanized
 14X18GLFM(1/8) 14" x 18" Gable Louver Flush Galvanized
 14X24GLFM(1/8) 14" x 24" Gable Louver Flush Galvanized



12RGL(1/8) 12" Round Gable Louver Bonderized
 18RGL(1/8) 18" Round Gable Louver Bonderized
 24RGL(1/8) 24" Round Gable Louver Bonderized



14X12RTGL(1/8) 14" x 12" Round Top Gable Louver Galvanized
 14X18RTGL(1/8) 14" x 18" Round Top Gable Louver Galvanized
 14X24RTGL(1/8) 14" x 24" Round Top Gable Louver Galvanized

UTILITY LOUVER

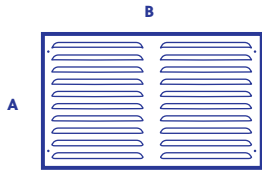

8X6UL 8" x 6" Utility Louver 26GA Zincalume
 8X12UL 8" x 12" Utility Louver 26GA Zincalume

VENTILATION

MADE WITH 1/8" MESH (1/4" MESH AVAILABLE UPON REQUEST)

FOUNDATION & EAVE VENTS

DIMENSIONS = A" x B"

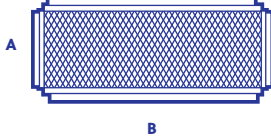
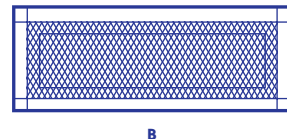
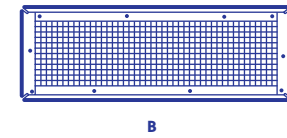
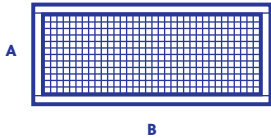
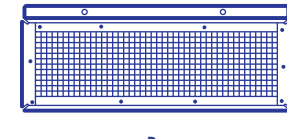
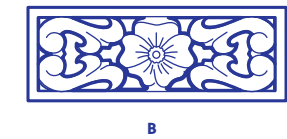
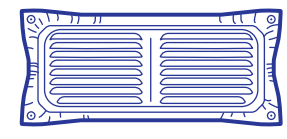
| | PRODUCT # | DESCRIPTION |
|---|---------------|--|
|  | 3X14EV(1/8) | 3" x 14" Eave Vent (Plaster Ground 3 Sides) |
| | 6X14FV(1/8) | 6" x 14" Foundation Vent Complete |
| | 6X14FV2W(1/8) | 6" x 14" Foundation Vent Complete 2-Way |
|  | 3X14EI(1/8) | 3" x 14" Eave Insert |
| | 6X14FI(1/8) | 6" x 14" Foundation Insert |
|  | 3X14EISI(1/8) | 3" x 14" Eave Insert Snap-In |
| | 6X14FISI(1/8) | 6" x 14" Foundation Insert Snap-In |
|  | 3X14FSV(1/8) | 3" x 14" Flat Siding Vent |
| | 6X14FSV(1/8) | 6" x 14" Flat Siding Vent |
|  | 3X14EVWE(1/8) | 3" x 14" Eave Vent with Ears |
| | 6X14EVWE(1/8) | 6" x 14" Eave Vent with Ears |
| | 3X22EVWE(1/8) | 3" x 22" Eave Vent with Ears (For 2X4 Rafters) |
| | 6X22EVWE(1/8) | 6" x 22" Eave Vent with Ears (For 2X6 Rafters) |
|  | 6X14PI | 6" x 14" Plastic Insert |
|  | 6X14PL | 6" x 14" Pressed Louver 26GA Galvanized |
| | 6X14PLS2(1/8) | 6" x 14" Pressed Louver w/Screen 26GA Bonderized |
| | 6X14PLS7(1/8) | 6" x 14" Pressed Louver w/Screen Copper |
| | 6X14PL7 | 6" x 14" Pressed Louver Copper |

CRAWL HOLE VENT

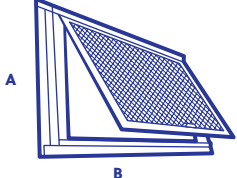
| | | |
|---|------------|--|
|  | CHV | 18" x 24" Crawl Hole Vent (Door and Frame) |
| | CHVDO | 18" x 24" Crawl Hole Vent (Door Only) |
| | 20X24CHV | 20" x 24" Crawl Hole Vent (Door and Frame) |
| | 20X24CHVDO | 20" x 24" Crawl Hole Vent (Door Only) |

VENTILATION

TUB ACCESS DOOR

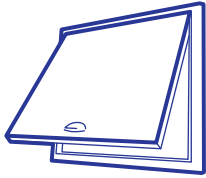

PRODUCT

DESCRIPTION

TADSI½

Tub Access Door (½" Plaster Ground) Snap-In

TADSI¾

Tub Access Door (¾" Plaster Ground) Snap-In

DRYER VENT

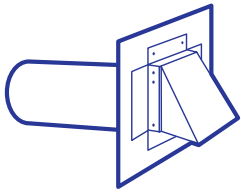

4GDV

4" Galvanized Dryer Vent Front Flange

4GDVPG

4" Galvanized Dryer Vent Plaster Ground (shown)

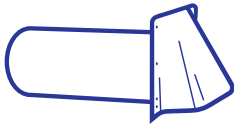

4ADV

4" Aluminum Dryer Vent

SIDE HOOD

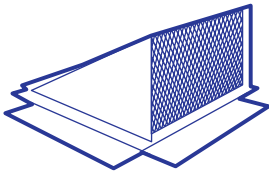

4X4SH

4" x 4" Side Hood Galvanized

7X7SH

7" x 7" Side Hood Galvanized

3.5X10SH

3½" x 10" Side Hood Galvanized

ALUMINUM LOUVER VENT



4X16ALVM

4"x16" Aluminum Louver Vent Screen Mesh

4X16ALV4

4"x16" Aluminum Louver Vent Brown Screen Mesh

4X16ALV5

4"x16" Aluminum Louver Vent White Screen Mesh

8X16ALVM

8"x16" Aluminum Louver Vent Screen Mesh

8X16ALV4

8"x16" Aluminum Louver Vent Brown Screen Mesh

8X16ALV5

8"x16" Aluminum Louver Vent White Screen Mesh

VENT PIPE & FITTINGS

VENT PIPE

PRODUCT #

DESCRIPTION

DIMENSIONS = A" x B" (x C")

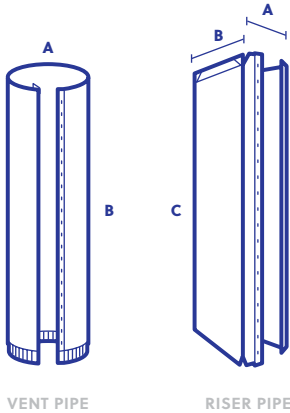

VENT PIPE

RISER PIPE

| | |
|------|--|
| 3X30 | 3" x 30" Vent Pipe 30 Gauge (Knock Down) SOLD IN BOXES OF 36 PIECES ONLY |
| 4X30 | 4" x 30" Vent Pipe 30 Gauge (Knock Down) SOLD IN BOXES OF 20 PIECES ONLY |
| 4X36 | 4" x 36" Vent Pipe 30 Gauge (Knock Down) |
| 5X30 | 5" x 30" Vent Pipe 30 Gauge (Knock Down) |
| 5X36 | 5" x 36" Vent Pipe 30 Gauge (Knock Down) |
| 6X30 | 6" x 30" Vent Pipe 30 Gauge (Knock Down) |
| 6X36 | 6" x 36" Vent Pipe 30 Gauge (Knock Down) |
| 7X30 | 7" x 30" Vent Pipe 30 Gauge (Knock Down) |
| 7X36 | 7" x 36" Vent Pipe 30 Gauge (Knock Down) |
| 7X60 | 7" x 60" Vent Pipe 30 Gauge (Knock Down) |
| 8X30 | 8" x 30" Vent Pipe 30 Gauge (Knock Down) |
| 8X36 | 8" x 36" Vent Pipe 30 Gauge (Knock Down) |

AVAILABLE IN 26 & 28 GAUGE

RP 3½" x 10" x 36" Riser Pipe (Knock Down)

CONDUCTOR PIPE

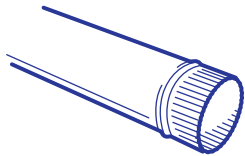

| | |
|-----|---|
| 3CP | 3" x 10' Conductor Pipe 30 Gauge Galvanized |
| 4CP | 4" x 10' Conductor Pipe 30 Gauge Galvanized |
| 5CP | 5" x 10' Conductor Pipe 28 Gauge Galvanized |
| 6CP | 6" x 10' Conductor Pipe 28 Gauge Galvanized |

AVAILABLE IN 26, 28 & 30 GAUGE

ELBOWS

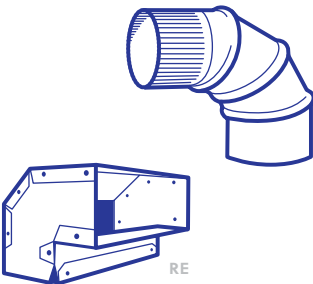

| | |
|------|-------------------------|
| 3ADJ | 3" Adjustable Elbow 90° |
| 4ADJ | 4" Adjustable Elbow 90° |
| 5ADJ | 5" Adjustable Elbow 90° |
| 6ADJ | 6" Adjustable Elbow 90° |
| 7ADJ | 7" Adjustable Elbow 90° |
| 8ADJ | 8" Adjustable Elbow 90° |

ELBOWS AVAILABLE IN 26 OR 30 GAUGE

RE 3½" x 10" Riser Elbow "A"

RECTANGLE TO ROUND ADAPTER

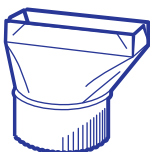

| | |
|------|-----------------------------|
| ADP | ¾" x 10" - 7" Round Adapter |
| ADP6 | ¾" x 10" - 6" Round Adapter |



VENT PIPE & FITTINGS

PLUMBERS TAPE



PRODUCT #

DESCRIPTION

PT10

¾" x 10' Plumbers Tape
SOLD INDIVIDUALLY OR 100 PIECES PER BOX

INCREASERS

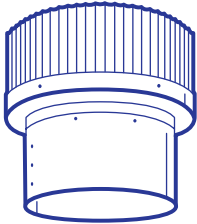

| | |
|------|-------------------|
| 3-4I | 3" - 4" Increaser |
| 4-5I | 4" - 5" Increaser |
| 4-6I | 4" - 6" Increaser |
| 4-7I | 4" - 7" Increaser |
| 5-6I | 5" - 6" Increaser |
| 5-7I | 5" - 7" Increaser |
| 6-7I | 6" - 7" Increaser |
| 6-8I | 6" - 8" Increaser |
| 7-8I | 7" - 8" Increaser |

REDUCERS

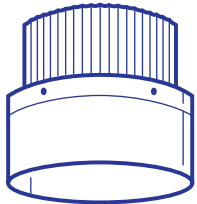

| | |
|------|-----------------|
| 4-3R | 4" - 3" Reducer |
| 5-4R | 5" - 4" Reducer |
| 6-4R | 6" - 4" Reducer |
| 6-5R | 6" - 5" Reducer |
| 7-4R | 7" - 4" Reducer |
| 7-5R | 7" - 5" Reducer |
| 7-6R | 7" - 6" Reducer |
| 8-6R | 8" - 6" Reducer |
| 8-7R | 8" - 7" Reducer |

VENT TEES & WYES

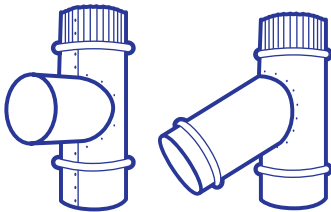

TEE

| | |
|-----|-------------|
| 3VT | 3" Vent Tee |
| 4VT | 4" Vent Tee |
| 3VY | 3" Vent Wye |
| 4VY | 4" Vent Wye |
| 6VY | 6" Vent Wye |

VENT PIPE COLLAR

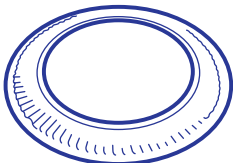

| | |
|------|---------------------|
| 3VPC | 3" Vent Pipe Collar |
| 4VPC | 4" Vent Pipe Collar |
| 5VPC | 5" Vent Pipe Collar |
| 6VPC | 6" Vent Pipe Collar |
| 7VPC | 7" Vent Pipe Collar |

VENT PIPE & FITTINGS

CAPS

PRODUCT

DESCRIPTION

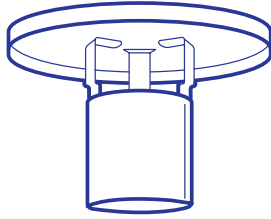

| | |
|-----|--------------------------|
| 3CC | 3" Chimney Cap (Economy) |
| 4CC | 4" Chimney Cap (Economy) |
| 5CC | 5" Chimney Cap (Economy) |
| 6CC | 6" Chimney Cap (Economy) |
| 7CC | 7" Chimney Cap (Economy) |
| 8CC | 8" Chimney Cap (Economy) |

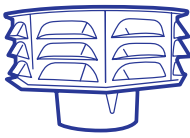

LOUVERED

| | |
|------|------------------------------|
| 3RAC | 3" All Purpose Cap, Louvered |
| 4RAC | 4" All Purpose Cap, Louvered |
| 5RAC | 5" All Purpose Cap, Louvered |
| 6RAC | 6" All Purpose Cap, Louvered |
| 7RAC | 7" All Purpose Cap, Louvered |
| 8RAC | 8" All Purpose Cap, Louvered |

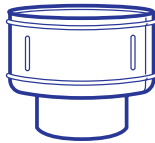

PLAIN

| | |
|-------|---------------------------|
| 3RACW | 3" All Purpose Cap, Plain |
| 4RACW | 4" All Purpose Cap, Plain |
| 5RACW | 5" All Purpose Cap, Plain |
| 6RACW | 6" All Purpose Cap, Plain |
| 7RACW | 7" All Purpose Cap, Plain |
| 8RACW | 8" All Purpose Cap, Plain |

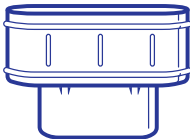

| | |
|------|-------------------------|
| 4OCW | 4" Oval All Purpose Cap |
| 5OCW | 5" Oval All Purpose Cap |

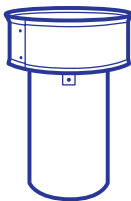

| | |
|----------|---|
| 4NOLLO25 | 4" Flashing and Cap Assembly "Code Cap" |
|----------|---|

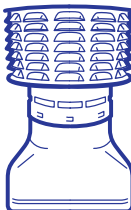

| | |
|------|-----------------------------|
| 6OCA | 6" Oval Cap and Adapter Set |
|------|-----------------------------|

VENT PIPE & FITTINGS

FLEXIBLE ALUMINUM PIPE

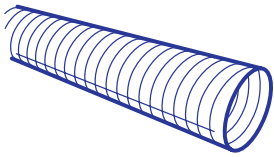

PRODUCT # DESCRIPTION

| | |
|------|-----------------------------|
| 3AFP | 3" x 10' Flexible Vent Pipe |
| 4AFP | 4" x 10' Flexible Vent Pipe |
| 5AFP | 5" x 10' Flexible Vent Pipe |
| 6AFP | 6" x 10' Flexible Vent Pipe |
| 7AFP | 7" x 10' Flexible Vent Pipe |
| 8AFP | 8" x 10' Flexible Vent Pipe |

PIPE IS DELIVERED COMPRESSED

DRYER BOX



| | |
|-------|---|
| DB350 | Dryer Wall Box 2" X 4" Frame (6 pieces per box) |
| DB425 | Dryer Wall Box 2" X 6" Frame (5 pieces per box) |

DRYER VENT KIT

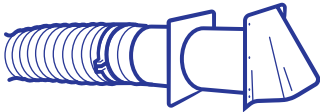

| | |
|-------|--|
| 4ADVK | Dryer Vent Kit w/Aluminum Hood, Mtl. Clamps & Collar and Flexible 4" X 8' Hose Foil Pipe |
|-------|--|

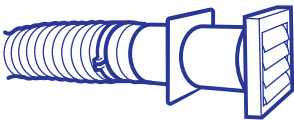

| | |
|-------|--|
| 4LDVK | Dryer Vent Kit w/White Louver Vinyl Hood, Mtl. Clamps & Collar and Flexible 4" X 8' Hose Foil Pipe |
|-------|--|

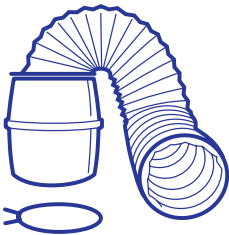

| | |
|------|---|
| DLTK | Lint Trap Kit For Electric Dryer with 4" X 5' Hose Silver Foil Pipe & Spring Clamps |
|------|---|

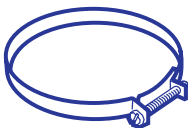

| | |
|-----|-----------------------------------|
| 4SC | 4" Steel Dryer Screw Clamp (2 pc) |
|-----|-----------------------------------|

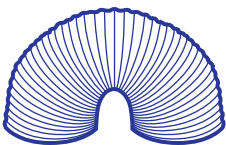

| | |
|---------|---|
| 4X8FFP | 4" X 8' Flexible Hose Silver Foil Pipe |
| 4X20FFP | 4" X 20' Flexible Hose Silver Foil Pipe |

| | |
|------|-------------------------------|
| 4SFC | 4" Dryer Silver Flex Coupling |
|------|-------------------------------|



RANGE HOOD & BATHROOM FAN VENT SYSTEM

Note: Contact your local building department for all questions regarding building code requirements.

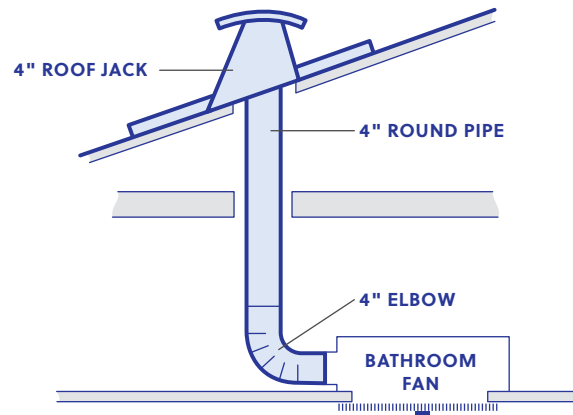
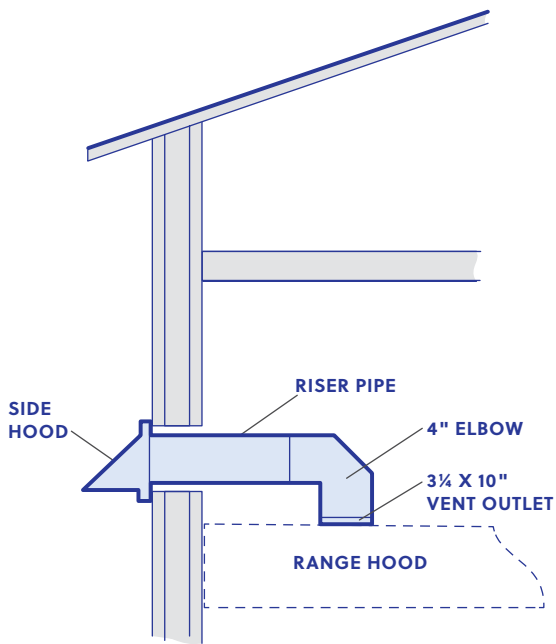
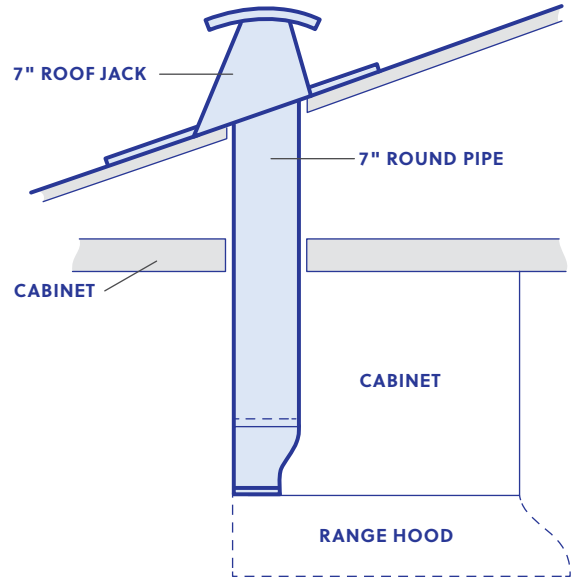
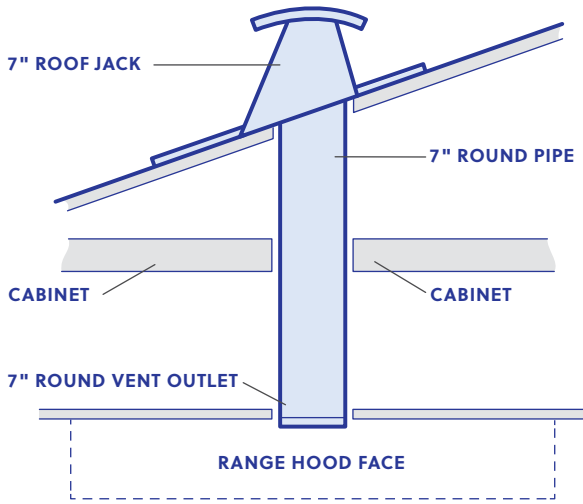

DOUBLE WALL VENT PIPE & FITTINGS

ROUND DOUBLE WALL PIPE & ACCESSORIES

| | PRODUCT # | DESCRIPTION |
|---|--|---|
|  | 3E24W | 3" (A) x 2' Round Double Wall Pipe |
| | 3E3W | 3" (A) x 3' Round Double Wall Pipe |
| | 3E4W | 3" (A) x 4' Round Double Wall Pipe |
| | 3E5W | 3" (A) x 5' Round Double Wall Pipe |
| | 4E24W | 4" (A) x 2' Round Double Wall Pipe |
|  | 4E3W | 4" (A) x 3' Round Double Wall Pipe |
| | 4E4W | 4" (A) x 4' Round Double Wall Pipe |
| | 4E5W | 4" (A) x 5' Round Double Wall Pipe |
| | 5E24W | 5" (A) x 2' Round Double Wall Pipe |
|  | 5E3W | 5" (A) x 3' Round Double Wall Pipe |
| | 5E5W | 5" (A) x 5' Round Double Wall Pipe |
| |  | 3E45W |
| 4E45W | | 4" Round Double Wall Adjustable Elbow 45° |
|  | 3EALW | 3" Round Double Wall Adjustable Elbow 90° |
| | 4EALW | 4" Round Double Wall Adjustable Elbow 90° |
| | 5EALW | 5" Round Double Wall Adjustable Elbow 90° |
|  | 3RSC | 3" Adjustable Storm Collar |
| | 4RSC | 4" Adjustable Storm Collar |
| | 5RSC | 5" Adjustable Storm Collar |
| | 6RSC | 6" Adjustable Storm Collar |
| | 7RSC | 7" Adjustable Storm Collar |
|  | 3VPHW | 3" Vent Pipe Hanger |
| | 4VPHW | 4" Vent Pipe Hanger |
|  | 3-4BHW | 3" - 4" Bucket Hanger Set |

32 **WATER HEATER VENT SYSTEM**

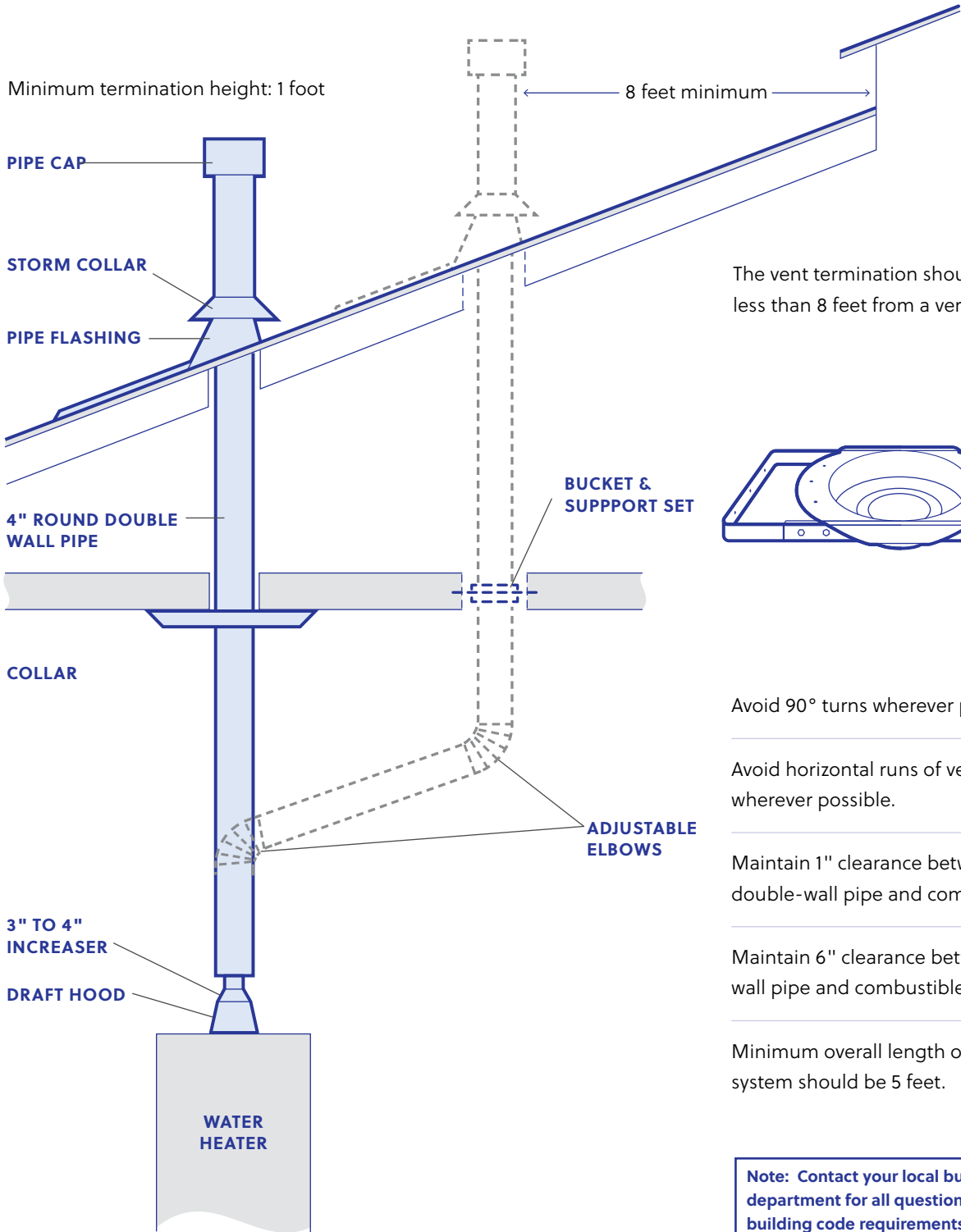

The vent termination should not be less than 8 feet from a vertical wall.

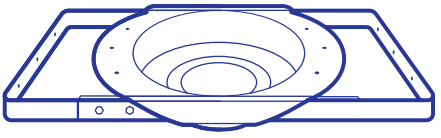

Avoid 90° turns wherever possible.

Avoid horizontal runs of vent pipe wherever possible.

Maintain 1" clearance between double-wall pipe and combustibles.

Maintain 6" clearance between single wall pipe and combustibles.

Minimum overall length of vent system should be 5 feet.

Note: Contact your local building department for all questions regarding building code requirements.



DOUBLE WALL VENT PIPE & FITTINGS

OVAL DOUBLE WALL PIPE & ACCESSORIES

PRODUCT #

DESCRIPTION

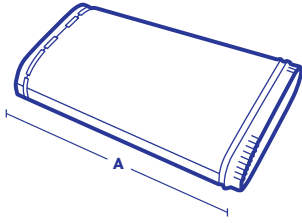

4O24W

4" x 2' (A) Oval Double Wall Pipe

4O3W

4" x 3' (A) Oval Double Wall Pipe

4O4W

4" x 4' (A) Oval Double Wall Pipe

4O5W

4" x 5' (A) Oval Double Wall Pipe

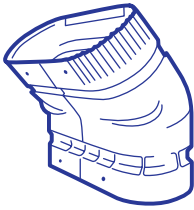

4O45SW

4" Oval Double Wall Elbow 45°

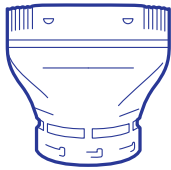

4OEW

4" Oval to Round Adapter

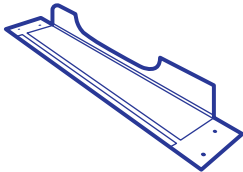

4OFSW

4" Oval Firestop Spacers (2 Pieces)



4OPSW

4" Plate Spacers (2 Pieces)

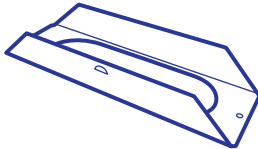

4OHDW

Hold Down Plate

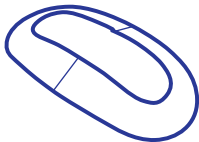

4OSC

4" Oval Double Wall Pipe Storm Collar

5OSC

5" Oval Double Wall Pipe Storm Collar

6OSC

6" Oval Double Wall Pipe Storm Collar

VIP

Venting Instruction Pad (50 Sheets)

WALL FURNACE VENT SYSTEM

USING 4" OVAL & 4" ROUND DOUBLE WALL PIPE

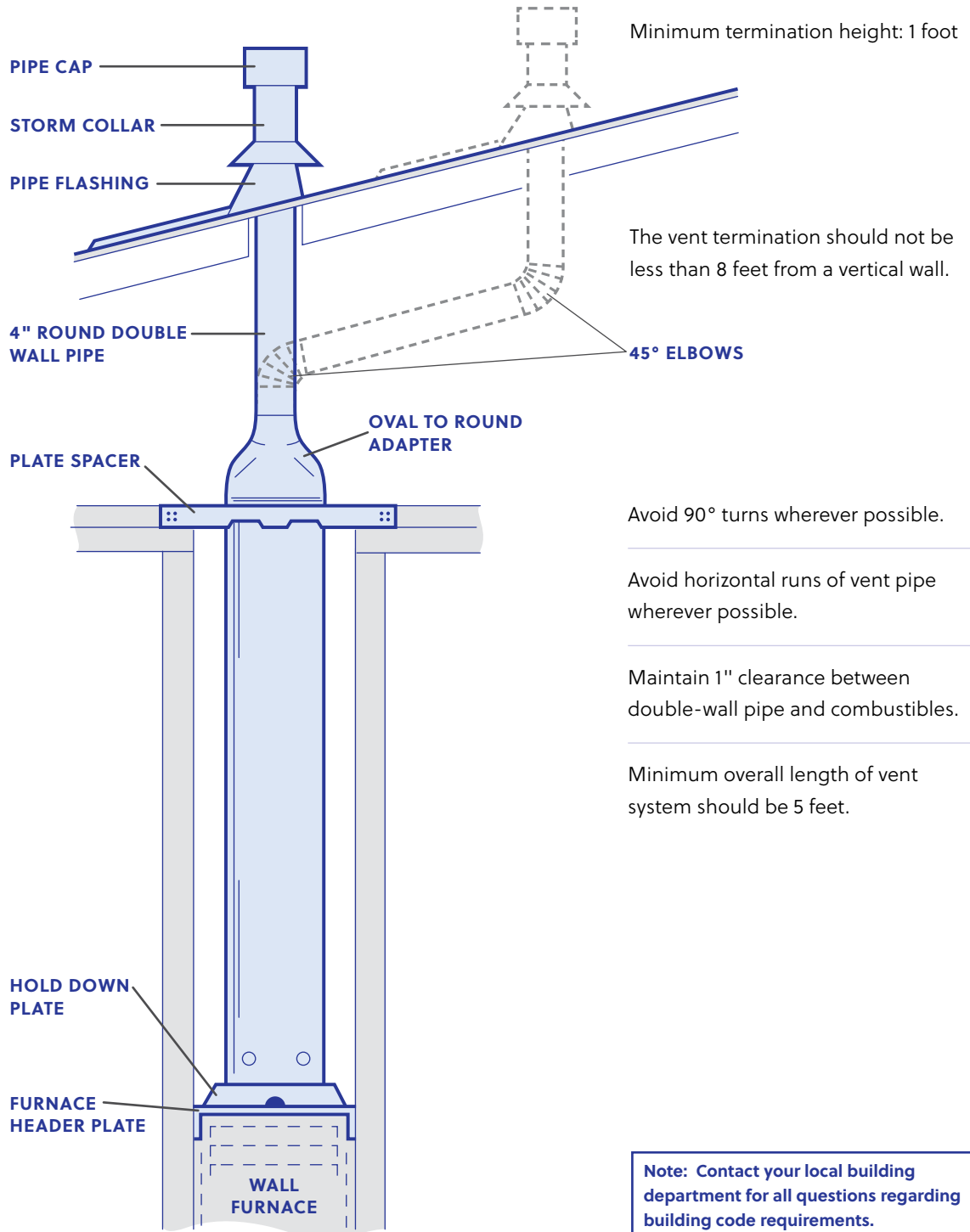

Minimum termination height: 1 foot

The vent termination should not be less than 8 feet from a vertical wall.

Avoid 90° turns wherever possible.

Avoid horizontal runs of vent pipe wherever possible.

Maintain 1" clearance between double-wall pipe and combustibles.





Minimum overall length of vent system should be 5 feet.

Note: Contact your local building department for all questions regarding building code requirements.

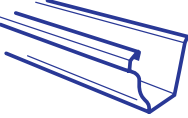
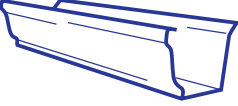
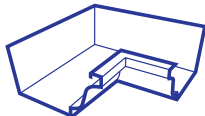
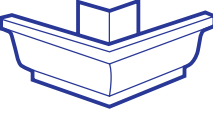

GUTTERS

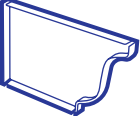
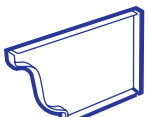
K4 GUTTERS

| | PRODUCT # | DESCRIPTION |
|---|-----------|-------------------------------------|
|  | K4 | K4 Gutter 10' Galvanized |
| | K44 | K4 Gutter 10' Brown |
| | K45 | K4 Gutter 10' White |
|  | GEXT | K4 Gutter Extension 12" Galvanized |
| | GEXT4 | K4 Gutter Extension 12" Brown |
| | GEXT5 | K4 Gutter Extension 12" White |
|  | ISM | K4 Inside Miter Galvanized |
| | ISM4 | K4 Inside Miter Brown |
| | ISM5 | K4 Inside Miter White |
|  | OSM | K4 Outside Miter Galvanized |
| | OSM4 | K4 Outside Miter Brown |
| | OSM5 | K4 Outside Miter White |
|  | C | K4 Slip Connector Galvanized |
| | C4 | K4 Slip Connector Brown |
| | C5 | K4 Slip Connector White |
|  | REC | K4 Right Hand End Cap Galvanized |
| | REC4 | K4 Right Hand End Cap Brown |
| | REC5 | K4 Right Hand End Cap White |
|  | LEC | K4 Left Hand End Cap Galvanized |
| | LEC4 | K4 Left Hand End Cap Brown |
| | LEC5 | K4 Left Hand End Cap White |
|  | EP | K4 End Piece with Outlet Galvanized |
| | EP4 | K4 End Piece with Outlet Brown |
| | EP5 | K4 End Piece with Outlet White |

GUTTERS

K4 GUTTERS

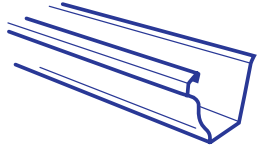

PRODUCT

DESCRIPTION

| | |
|---------|-----------------------------------|
| K42610 | K4 Gutter 10' 26 Gauge Galvanized |
| K42620 | K4 Gutter 20' 26 Gauge Galvanized |
| K426102 | K4 Gutter 10' 26 Gauge Bonderized |
| K426202 | K4 Gutter 20' 26 Gauge Bonderized |
| K42810 | K4 Gutter 10' 28 Gauge Galvanized |
| K42820 | K4 Gutter 20' 28 Gauge Galvanized |
| K428102 | K4 Gutter 10' 28 Gauge Bonderized |
| K428202 | K4 Gutter 20' 28 Gauge Bonderized |

K5 GUTTERS

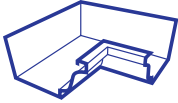

K5ISM

K5 Inside Miter



K5OSM

K5 Outside Miter



K5C

K5 Slip Connector 28 Gauge Galvanized

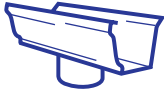

K5EP

K5 End Piece With Outlet 28 Gauge Galvanized

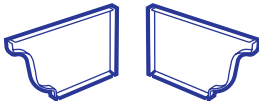

K5REC

K5 Right Hand End Cap Galvanized

K5LEC

K5 Left Hand End Cap Galvanized

K5 GUTTERS

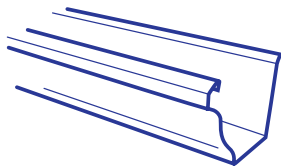

| | |
|---------|-----------------------------------|
| K52610 | K5 Gutter 10' 26 Gauge Galvanized |
| K52620 | K5 Gutter 20' 26 Gauge Galvanized |
| K526102 | K5 Gutter 10' 26 Gauge Bonderized |
| K526202 | K5 Gutter 20' 26 Gauge Bonderized |
| K52810 | K5 Gutter 10' 28 Gauge Galvanized |
| K52820 | K5 Gutter 20' 28 Gauge Galvanized |
| K528102 | K5 Gutter 10' 28 Gauge Bonderized |
| K528202 | K5 Gutter 20' 28 Gauge Bonderized |



ROOF DRAINAGE SYSTEM

You may find this sheet to be a handy aid when your customer is deciding what they need to complete their project. We have gutter instruction pads available free of charge.

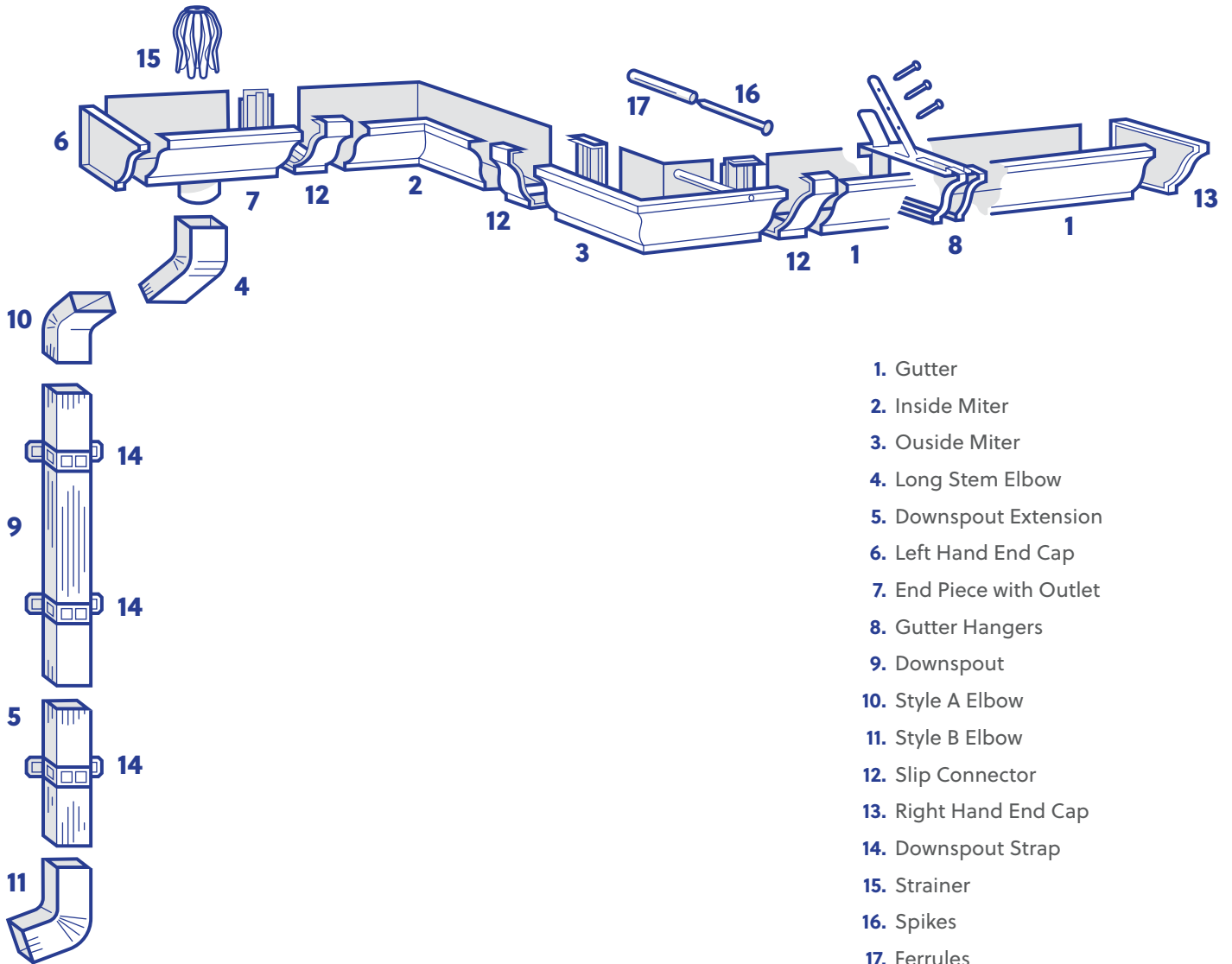

1. Gutter
2. Inside Miter
3. Outside Miter
4. Long Stem Elbow
5. Downspout Extension
6. Left Hand End Cap
7. End Piece with Outlet
8. Gutter Hangers
9. Downspout
10. Style A Elbow
11. Style B Elbow
12. Slip Connector
13. Right Hand End Cap
14. Downspout Strap
15. Strainer
16. Spikes
17. Ferrules

WARNING: We recommend the use of gloves when handling sheet metal products to avoid cuts.

EASY INSTALLATION INSTRUCTIONS

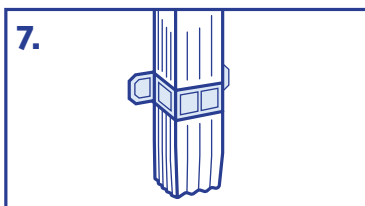
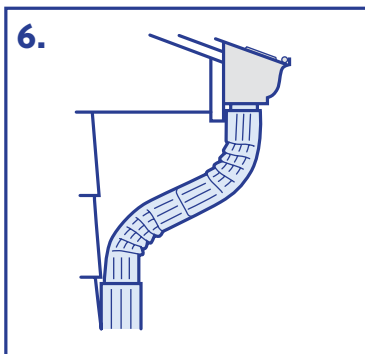
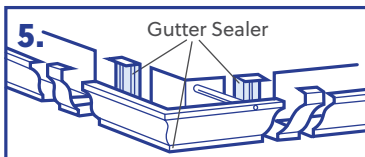
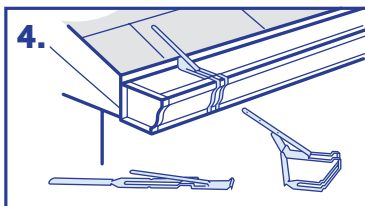
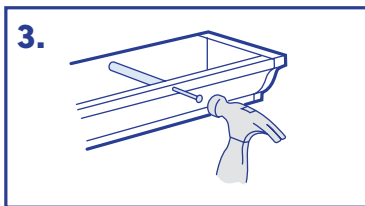
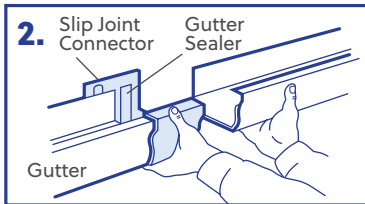
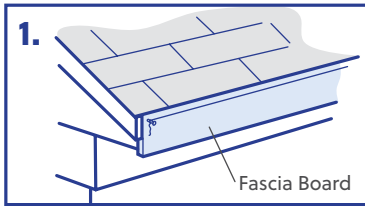

TOOLS NEEDED

Hammer, Screwdriver, Tape Measure, String, Pliers, Hacksaw, Tin Snips, Ladder.

1. STRING MARK THE GUTTER SLOPE

Gutter should slope down 1" for every forty feet towards the downspout. At the higher end, tack a string to the opposite end (the downspout end), and tack it level. Then measure down the desired drop and re-tack.

2. GUTTER ASSEMBLY

Begin at the end of the gutter opposite the downspout. First fit the end cap on the gutter securing it with pop rivets or sheet metal screws. Then seal it with gutter sealer. To join together two gutter sections, use a slip connector. Generously apply gutter sealer to one side of the slip joint connector – insert the gutter end into the connector. Apply gutter sealer to the other side of the connector – insert the second gutter end, pressing firmly to complete the connections. Bend front of slip joint over gutter connections and crimp.

3. HANGING THE GUTTER

SPIKE & FERRULE METHOD

The SPIKE & FERRULE method is always the preferred method. To start, position the gutter with the top edge lined up against the guide string. Place a ferrule inside the gutter and drive a spike through the front gutter lip, the ferrule, and the back edge of the gutter into the fascia board, where the fascia and a rafter meet. A spike and ferrule should be used at every other rafter support.

4. HANGING THE GUTTER

WRAPAROUND GUTTER HANGER METHOD

Use a wraparound gutter hanger only when there is no wooden fascia board. While the gutter is still on the ground, attach hangers every 2 to 3 feet. Align the gutter with the guide string and nail the hangers to the roof boards under the shingles.

5. ATTACH MITERS

Attach miters to the gutter run where necessary. Use a slip connector between gutter section and miter. Apply gutter sealer after connection is completed.

6. ATTACH DOWNSPOUT ELBOWS









Each downspout section and elbow has one crimped end. Parts are joined by forcing the larger end of one over the smaller end of the other and forcing them together tightly. Downspouts should fit snugly against the wall. Attach an "A" or a "B" elbow at the bottom of the downspout to direct the water away from the foundation.

7. ATTACH THE DOWNSPOUT

Fasten each downspout against the wall using 2 downspout straps. Attach straps using the appropriate fastener (nails, screws, etc.)

DOWNSPOUTS

K4 DOWNSPOUT ELBOWS





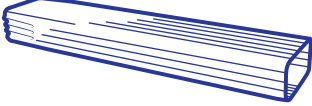
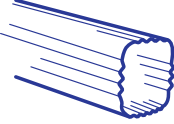

| | PRODUCT # | DESCRIPTION |
|---|-----------|--------------------------------------|
|  | LS | Downspout Elbow Long Stem Galvanized |
| | LS4 | Downspout Elbow Long Stem Brown |
| | LS5 | Downspout Elbow Long Stem White |
| A Style | | |
|  | 1A | 1A Downspout Elbow 45° Galvanized |
| | 1A4 | 1A Downspout Elbow 45° Brown |
| | 1A5 | 1A Downspout Elbow 45° White |
|  | 2A | 2A Downspout Elbow 60° Galvanized |
| | 2A4 | 2A Downspout Elbow 60° Brown |
| | 2A5 | 2A Downspout Elbow 60° White |
|  | 3A | 3A Downspout Elbow 75° Galvanized |
| | 3A4 | 3A Downspout Elbow 75° Brown |
| | 3A5 | 3A Downspout Elbow 75° White |
|  | 4A | 4A Downspout Elbow 90° Galvanized |
| | 4A4 | 4A Downspout Elbow 90° Brown |
| | 4A5 | 4A Downspout Elbow 90° White |
| B Style | | |
|  | 1B | 1B Downspout Elbow 45° Galvanized |
| | 1B4 | 1B Downspout Elbow 45° Brown |
| | 1B5 | 1B Downspout Elbow 45° White |
|  | 2B | 2B Downspout Elbow 60° Galvanized |
| | 2B4 | 2B Downspout Elbow 60° Brown |
| | 2B5 | 2B Downspout Elbow 60° White |
|  | 3B | 3B Downspout Elbow 75° Galvanized |
| | 3B4 | 3B Downspout Elbow 75° Brown |
| | 3B5 | 3B Downspout Elbow 75° White |
|  | 4B | 4B Downspout Elbow 90° Galvanized |
| | 4B4 | 4B Downspout Elbow 90° Brown |
| | 4B5 | 4B Downspout Elbow 90° White |

DOWNPOUTS

K4 DOWNPOUTS

| | PRODUCT # | DESCRIPTION |
|---|-----------|---|
|  | DSEXT | Downspout Extension 15" Galvanized |
| | DSEXT4 | Downspout Extension 15" Brown |
| | DSEXT5 | Downspout Extension 15" White |
|  | DS | 2" X 3" Corrugated Downspout 10' Galvanized |
| | DS4 | 2" X 3" Corrugated Downspout 10' Brown |
| | DS5 | 2" X 3" Corrugated Downspout 10' White |

PLAIN ROUND ELBOWS





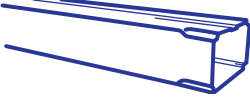





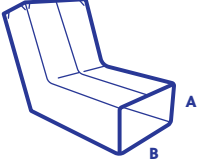







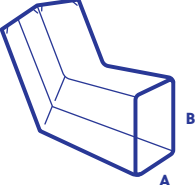

| | | |
|--|--|---------------------------|
|  |  3PRE45 | 3" Plain Round Elbow 45° |
| |  3PRE75 | 3" Plain Round Elbow 75 ° |
| |  3PRE90 | 3" Plain Round Elbow 90° |
| |  4PRE45 | 4" Plain Round Elbow 45° |
| |  4PRE75 | 4" Plain Round Elbow 75 ° |
| |  4PRE90 | 4" Plain Round Elbow 90° |

PLAIN SQUARE DOWNPOUT

| | | |
|---|----------|---|
|  | 2PSDS282 | 2" x 3" X 10' Plain Sq. Downspout Bonderized |
| | 3PSDS282 | 3" x 4" X 10' Plain Sq. Downspout Bonderized |
| | 2PSDS28 | 2" x 3" X 10' Plain Sq. Downspout 28GA Galvanized |
| | 3PSDS28 | 3" x 4" X 10' Plain Sq. Downspout 28GA Galvanized |
| | 4PSDS26 | 4" x 6" X 10' Plain Sq. Downspout 28GA Galvanized |

DOWNSPOUTS

PLAIN SQUARE ELBOWS

| | PRODUCT # | DESCRIPTION |
|---|---|--------------------------------|
| ALL DIMENSIONS = A" x B" | | |
| A Style | | |
|  |  2PSE45A | 2" x 3" Plain Square Elbow 45° |
| |  2PSE75A | 2" x 3" Plain Square Elbow 75° |
| |  2PSE90A | 2" x 3" Plain Square Elbow 90° |
| | <hr/> | |
| |  3PSE45A | 3" x 4" Plain Square Elbow 45° |
| |  3PSE75A | 3" x 4" Plain Square Elbow 75° |
| |  3PSE90A | 3" x 4" Plain Square Elbow 90° |
| | <hr/> | |
| |  4PSE45A | 4" x 6" Plain Square Elbow 45° |
|  4PSE75A | 4" x 6" Plain Square Elbow 75° | |
|  4PSE90A | 4" x 6" Plain Square Elbow 90° | |
| <hr/> | | |
| B Style | | |
|  |  2PSE45B | 2" x 3" Plain Square Elbow 45° |
| |  2PSE75B | 2" x 3" Plain Square Elbow 75° |
| |  2PSE90B | 2" x 3" Plain Square Elbow 90° |
| | <hr/> | |
| |  3PSE45B | 3" x 4" Plain Square Elbow 45° |
| |  3PSE75B | 3" x 4" Plain Square Elbow 75° |
| |  3PSE90B | 3" x 4" Plain Square Elbow 90° |
| | <hr/> | |
| |  4PSE45B | 4" x 6" Plain Square Elbow 45° |
|  4PSE75B | 4" x 6" Plain Square Elbow 75° | |
|  4PSE90B | 4" x 6" Plain Square Elbow 90° | |

GUTTER ACCESSORIES

K4 ACCESSORIES



| PRODUCT # | DESCRIPTION |
|-----------|----------------------------|
| DSS | Downspout Strap Galvanized |
| DSS4 | Downspout Strap Brown |
| DSS5 | Downspout Strap White |



| | |
|-----|----------------------------------|
| S | 7" Gutter Spikes Galvanized |
| F | 4" Ferrules Galvanized |
| S/F | Spike & Ferrule Set - 10 per bag |



| | |
|----|---|
| GH | K4 Wrap Around Gutter Hanger Galvanized |
|----|---|



| | |
|-----|----------------------------------|
| HGH | K4 Hidden Gutter Hanger - 10 pcs |
|-----|----------------------------------|



| | |
|--------|------------------------------------|
| 6X20GG | 6" X 20' Gutter Guard Plastic Mesh |
|--------|------------------------------------|



| | |
|----|-----------------------------|
| ST | 3" Round Downspout Strainer |
|----|-----------------------------|



| | |
|-----|--------------------|
| GOO | Gutter Oval Outlet |
|-----|--------------------|

K5 ACCESSORIES



| | |
|-------|-----------------------|
| K5GOO | K5 Gutter Oval Outlet |
|-------|-----------------------|



| | |
|-------|-------------------------|
| K5HGH | K5 Hidden Gutter Hanger |
|-------|-------------------------|



| | |
|-----|-------------|
| K5S | 8" Spikes |
| K5F | 5" Ferrules |

DOWNSPOUT STRAPS



| | |
|--------|--|
| LDS | 3" X 4" Large Downspout Strap Galvanized |
| LDS4X6 | 4" X 6" Large Downspout Strap Galvanized |

ROOF DRAINAGE

SCUPPERS

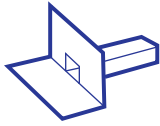

2X3S8

2" x 3" Scupper 10" Center Shank

3X4S8

3" x 4" Scupper 10" Center Shank

4X6S8

4" x 6" Scupper 10" Center Shank

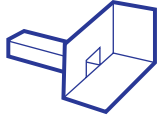

2X3S8R

2" x 3" Scupper 10" Right Shank

3X4S8R

3" x 4" Scupper 10" Right Shank

4X6S8R

4" x 6" Scupper 10" Right Shank

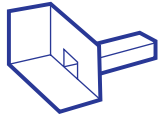

2X3S8L

2" x 3" Scupper 10" Left Shank

3X4S8L

3" x 4" Scupper 10" Left Shank

4X6S8L

4" x 6" Scupper 10" Left Shank

LEADER HEADS

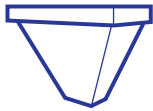

2X3LH

2" x 3" Leader Head

3X4LH

3" x 4" Leader Head

4X6LH

4" x 6" Leader Head

44 DRYWALL, PLASTER, STUCCO ACCESSORIES

DRYWALL

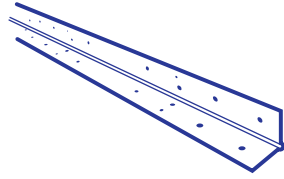

1.25CB8(C)
1.25CB10(C)

1¼" x 1¼" x 8' Drywall Cornerbead (70 pieces per box)
1¼" x 1¼" x 10' Drywall Cornerbead (56 pieces per box)

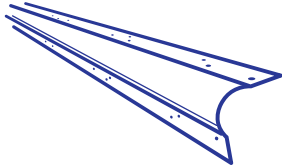

BULL8(C)
BULL10(C)

Bullnose Cornerbead 8' (40 pieces per box)
Bullnose Cornerbead 10' (40 pieces per box)

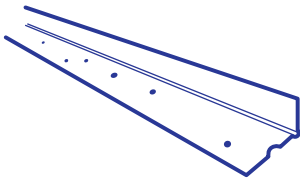

LM8(1/2)(C)
LM8(5/8)(C)
LM10(1/2)(C)
LM10(5/8)(C)

½" x 8' Drywall "L" Metal (75 pieces per box)
⅝" x 8' Drywall "L" Metal (75 pieces per box)
½" x 10' Drywall "L" Metal (60 pieces per box)
⅝" x 10' Drywall "L" Metal (60 pieces per box)



45 **DRYWALL, PLASTER, STUCCO
ACCESSORIES**

STUCCO

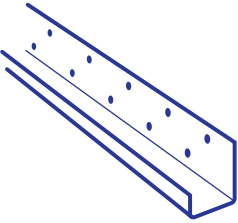
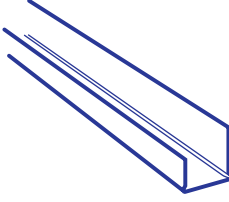
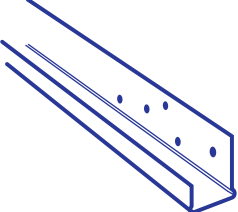
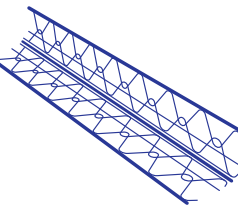
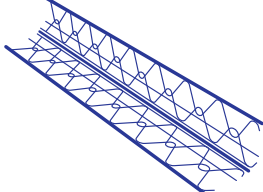
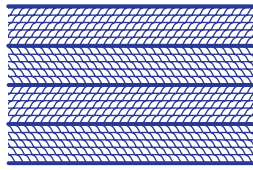
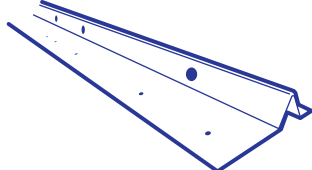
| | PRODUCT # | DESCRIPTION |
|---|------------------|---|
|  | 66CB8(C) | #66 Casing Bead 8' - Milcore (7/8" Grd) Galvanized (30 pieces) |
| | 66CB8(3/4)(C) | #66 Casing Bead 8' - Milcore (3/4" Grd) Galvanized (30 pieces) |
| | 66CB8(1/2)(C) | #66 Casing Bead 8' - Milcore (1/2" Grd) Galvanized (30 pieces) |
|  | 66CB10(C) | #66 Casing Bead 10' - Milcore (7/8" Grd) Galvanized (30 pieces) |
| | 66CB10(3/4)(C) | #66 Casing Bead 10' - Milcore (3/4" Grd) Galvanized (30 pieces) |
| | 66CB10(1/2)(C) | #66 Casing Bead 10' - Milcore (1/2" Grd) Galvanized (30 pieces) |
|  | JMETAL8(C) | "J" Metal 1/2" x 8' Zincalume (50 pieces) |
| | JMETAL8(5/8)(C) | "J" Metal 5/8" x 8' Zincalume (50 pieces) |
| | JMETAL10(C) | "J" Metal 1/2" x 10' Zincalume (50 pieces) |
| | JEMTAL10(5/8)(C) | "J" Metal 5/8" x 10' Zincalume (50 pieces) |
|  | UMETAL8(C) | U-Metal 1/2" X 8' w / Holes (50 pieces) |
| | UMETAL8(5/8)(C) | U-Metal 5/8" X 8' w / Holes (50 pieces) |
| | UMETAL(C) | U-Metal 1/2" X 10' w / Holes (50 pieces) |
| | UMETAL(5/8)(C) | U-Metal 5/8" X 10' w / Holes (50 pieces) |
|  | SCA8(C) | Corneraid 8' (40 pieces) |
| | SCA10(C) | Corneraid 10' (40 pieces) |
|  | 3/8 | 27" x 96" Painted 3/8" Rib Lath 3.4 |
|  | 4SBS | 4" Stucco Base Screed (7/8" Grd) 28 Gauge Galvanized |
| | 5.5SBS | 5 1/2" Stucco Base Screed (7/8" Grd) 26 Gauge Galvanized |
| | 5.5SBS28 | 5 1/2" Stucco Base Screed (7/8" Grd) 28 Gauge Galvanized |
| | 5.5SBS30 | 5 1/2" Stucco Base Screed (7/8" Grd) 30 Gauge Galvanized |

AVAILABLE IN COPPER



46 **DRYWALL, PLASTER, STUCCO
ACCESSORIES**

STUCCO

PRODUCT #

DESCRIPTION

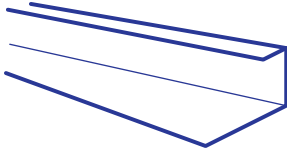

JSWH

1 1/2" J-Screed (With Holes) 1 Coat Stucco

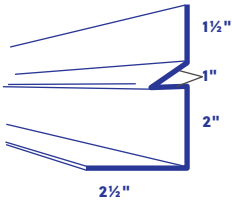

WTD2

Wall To Deck Diato 2" Back

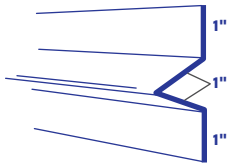

SBD

4" Straight Back Diato - 1" X 1" X 1" X 1"



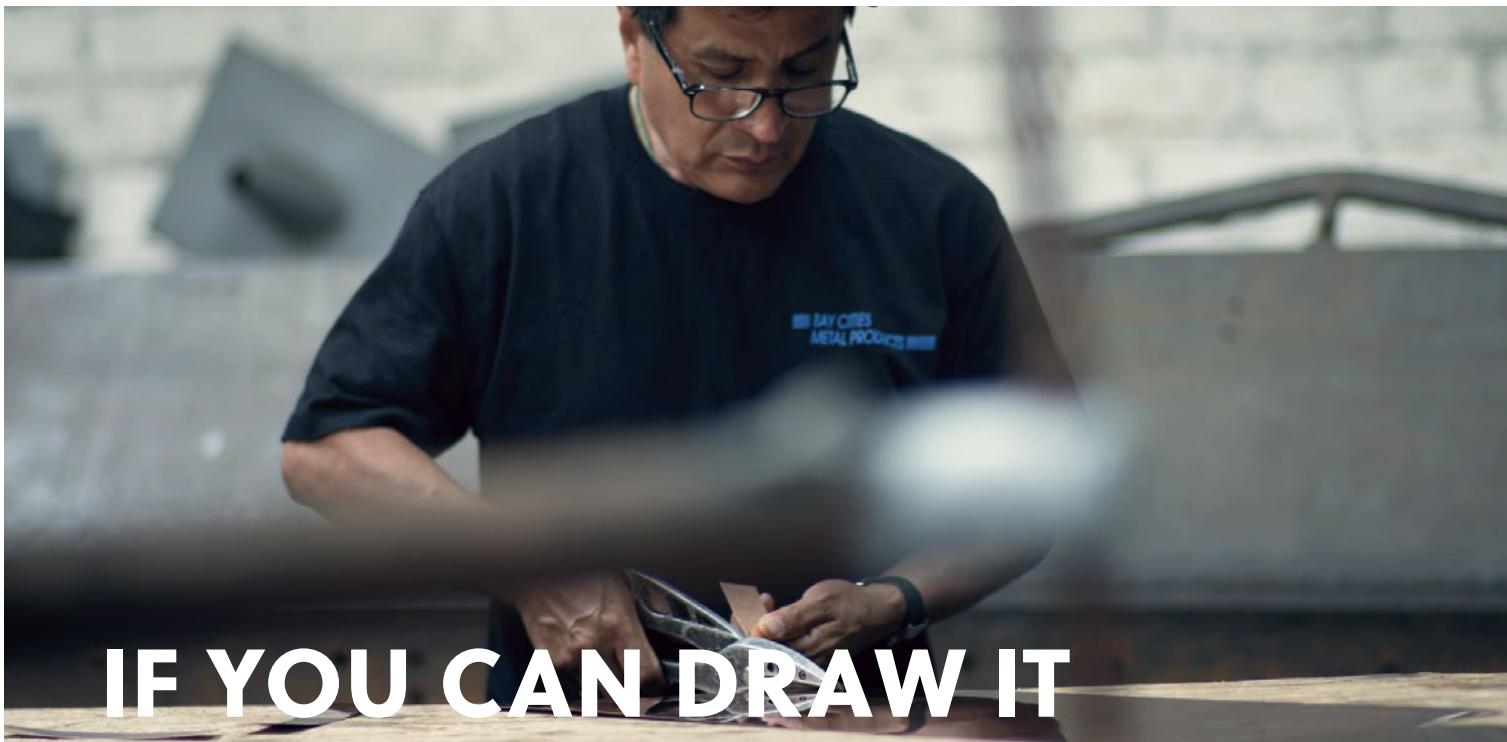

IF YOU CAN DRAW IT

WE CAN MAKE IT

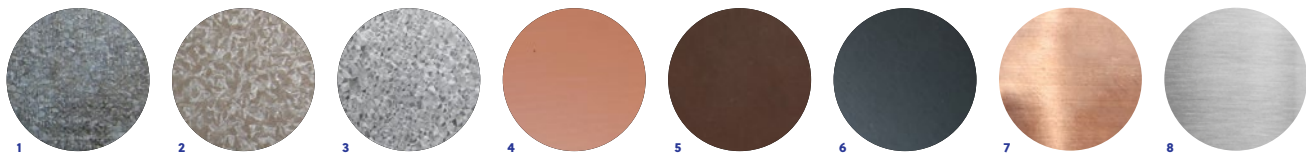

MATERIALS

We have a wide variety of raw materials in assorted metals and gauges available to suit your needs.

- Galvanized steel ①
- Bonderized steel ②
- Zinalume ③
- Prepainted Terra Cotta ④
- Prepainted brown ⑤
- Prepainted charcoal ⑥
- Copper ⑦
- Stainless steel ⑧
- Aluminum
- Prepainted white
- Single roof membranes

SPECIALTY ITEMS

Custom products are manufactured to customer specifications and are available in most common gauges of stainless, galvanized, bonderized, prepainted steel, aluminum, and copper.

- Pitch pockets ①
- Canted scuppers ②
- Pelican hood tops ③
- Pitched flashings ④
- Threshold sill pans
- Coping miters
- Downspout overflows
- Multi-Bend Custom Linear metal
- AC pans
- Chimney Crickets

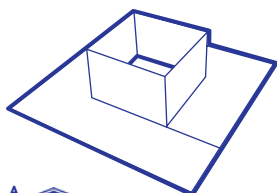

A

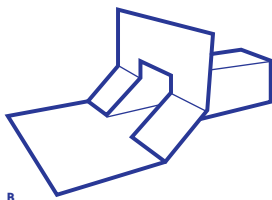

B

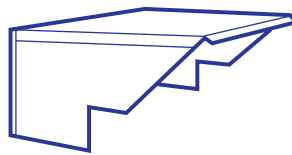

C

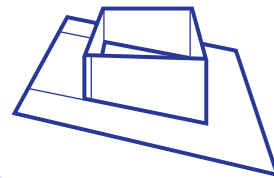

D



GARDENA • OAKLAND

(800) 245-9047

FAX (310) 515-7423

BCMET.COM



To place an order:
orders@bcmet.com

For pricing and other inquiries:
sales@bcmet.com

| | |
|--------------|--------------|
| PHONE | FAX |
| 800-245-9047 | 310-515-7423 |
| 310-660-0351 | |

[BCMET.COM](http://bcmet.com)

MAIN OFFICE
301 East Alondra Blvd
Gardena, CA 90248

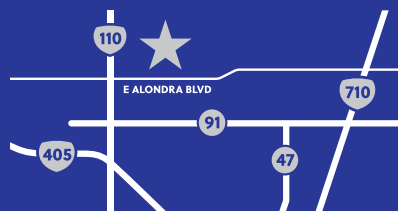

BAY AREA WAREHOUSE
1960 Mandela Pkwy, Bay 6
Oakland, CA 94607

